

KENWOOD

CD-RECEIVER

KDC-W808
KDC-W707

INSTRUCTION MANUAL

Kenwood Corporation



PHATNOISE



CH 01

Contents

Safety precautions	4	CD/Audio file/External disc control features	25
Notes	5	Playing CD & Audio file	
About CDs	7	Playing External Disc	
About AAC, MP3 and WMA	8	Fast Forwarding and Reversing	
General features	9	Track/File Search	
Power		Disc Search/Folder Search	
Hiding the Control Panel		Track/File/Disc/Folder Repeat	
Selecting the Source		Scan Play	
Volume		Random Play	
Attenuator		Magazine Random Play	
System Q		Disc Random Play	
Speaker Setting		Folder Select	
Audio Control		Switching the Play mode	
Audio Setup		Letter Seek	
Subwoofer Output		Disc Naming (DNPS)	
Display Setting		Text/Title Scroll	
Text Selection for Display			
Text Display Switching			
Graphic part/ Spectrum Analyzer Display Switching			
Faceplate Angle Adjustment			
Theft Deterrent Faceplate			
TEL Mute			
Tuner features	20	Menu system	31
Tuning		Menu System	
Station Preset Memory		Security Code	
Auto Memory Entry		Touch Sensor Tone	
Preset Tuning		Manual Clock Adjustment	
		Date Adjustment	
		Date Mode	
		Synchronize Clock	
		Dimmer	
		OFF Wait Time Setting	
		Switching preout	
		Built-in Amp Setting	
		Dual Zone System Setting	
		B.M.S. (Bass Management System)	
		B.M.S. Frequency Offset	
		AMP Control	
		News Bulletin with Timeout Setting	
		Local Seek	
		Tuning Mode	
		AF (Alternative Frequency)	
		Restricting RDS Region (Region Restrict Function)	
		Auto TP Seek	
		Monaural Reception	
		External Display Control	
		Auxiliary Input Display Setting & Disc Naming	
		Text Scroll	
		Built-in Auxiliary input Setting	
		Power OFF Timer	
		CD Read Setting	
		Voice Index	
		ACDrive firmware version display	
		Unique ID display	
		Audio Preset Memory	

Audio Preset Call
Selecting Russian Characters
Demonstration mode Setting

Accessories/ Installation Procedure	40
Connecting Wires to Terminals	41
Installation	43
Removing the Unit	44
Troubleshooting Guide	45
Specifications	48

The "AAC" logo is trademark of Dolby Laboratories.

Safety precautions

▲WARNING

To prevent injury or fire, take the following precautions:

- To prevent a short circuit, never put or leave any metallic objects (such as coins or metal tools) inside the unit.

▲CAUTION

To prevent damage to the machine, take the following precautions:

- Make sure to ground the unit to a negative 12V DC power supply.
- Do not install the unit in a spot exposed to direct sunlight or excessive heat or humidity. Also avoid places with too much dust or the possibility of water splashing.
- Do not place the faceplate or the faceplate case in areas exposed to direct sunlight, excessive heat or humidity. Also avoid places with too much dust or the possibility of water splashing.
- To prevent deterioration, do not touch the terminals of the unit or faceplate with your fingers.
- Do not subject the faceplate to excessive shock, as it is a piece of precision equipment.
- When replacing a fuse, only use a new fuse with the prescribed rating. Using a fuse with the wrong rating may cause your unit to malfunction.
- Do not apply excessive force to the open faceplate or place objects on it. Doing so will cause damage or breakdown.
- Do not use your own screws. Use only the screws provided. If you use the wrong screws, you could damage the unit.

Attach the panel while you are on the vehicle

The panel lock arm appears when the panel is removed. Therefore, the panel must be attached while the electrical system of the car is operating.

Do Not Load 8cm(3-in.) CDs in the CD slot

If you try to load a 8cm (3 in.) CD with its adapter into the unit, the adapter might separate from the CD and damage the unit.

About CD players/disc changers connected to this unit

Kenwood disc changers/ CD players released in 1998 or later can be connected to this unit.

Refer to the catalog or consult your Kenwood dealer for connectable models of disc changers/ CD players.

Note that any Kenwood disc changers/ CD players released in 1997 or earlier and disc changers made by other makers cannot be connected to this unit. Connecting unsupported disc changers/CD players to this unit may result in damage.

Set the "O-N" Switch to the "N" position for the applicable Kenwood disc changers/ CD players.

The functions you can use and the information that can be displayed may differ depending on the models being connected.



- You can damage both your unit and the CD changer if you connect them incorrectly.

Lens Fogging

When you turn on the car heater in cold weather, dew or condensation may form on the lens in the CD player of the unit. Called lens fogging, this condensation on the lens may not allow CDs to play. In such a situation, remove the disc and wait for the condensation to evaporate. If the unit still does not operate normally after a while, consult your Kenwood dealer.



Faceplate

- Use the enclosed or dedicated faceplate. Using a faceplate other than the specified one may cause your unit to malfunction.

Notes

- If you experience problems during installation, consult your Kenwood dealer.
- If the unit fails to operate properly, press the Reset button. The unit returns to factory settings when the Reset button is pressed.
- Press the reset button if the disc auto changer fails to operate correctly. Normal operation should be restored.

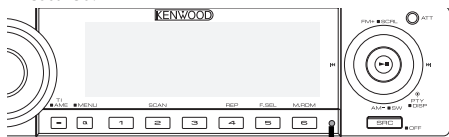

Reset button

- The characters conforming to ISO 8859-1 character set can be displayed
- The characters conforming to ISO 8859-5 or ISO 8859-1 character set can be displayed. Refer to <Selecting Russian Characters> (page 38). (Russian sales area of KDC-W707)
- There are places in this manual where lit indicators are described; however, the only time an indicator will light is in the following settings. When Indicator is selected as mentioned in <Text Display Switching> (page 15)
- The illustrations of the display and the panel appearing in this manual are examples used to explain more clearly how the controls are used. Therefore, what appears on the display in the illustrations may differ from what appears on the display on the actual equipment, and some of the illustrations on the display may represent something impossible in actual operation.

Cleaning the Unit

If the faceplate of this unit is stained, wipe it with a dry soft cloth such as a silicon cloth.

If the faceplate is stained badly, wipe the stain off with a cloth moistened with neutral cleaner, then wipe it again with a clean soft dry cloth.



- Applying spray cleaner directly to the unit may affect its mechanical parts. Wiping the faceplate with a hard cloth or using a volatile liquid such as thinner or alcohol may scratch the surface or erase characters.

Cleaning the Faceplate Terminals

If the terminals on the unit or faceplate get dirty, wipe them with a dry, soft cloth.

Before using this unit for the first time

This unit is initially set on the Demonstration mode. When using this unit for the first time, cancel the <Demonstration mode Setting> (page 39).

About DAB Tuner control

Refer to [A] group on the Instruction manual of DAB Tuner KTC-9090DAB (optional accessory) for the control method of DAB Tuner function.

However, the following control methods of the function for this unit may be different from the Instruction manual; therefore, refer to the following supplemental instruction.

<Auto Ensemble Memory Entry>

1. Select the preset band for Auto Ensemble Memory Entry.
2. Press the [AME] button for at least 2 seconds. Open Auto Ensemble Memory Entry. After storing in the memory finishes, the number of the pre-set buttons and the ensemble label are displayed.

<Searching by programme type and language> and <Languages to be displayed> in <Programme Type (PTY) Function>

At the operation to press [DISP] button, press [TI] button.

Notes

About "Media Manager" of PC application attached to KDC-W808

- "Media Manager" is recorded in the CD-ROM attached to this unit.
- Refer to the attached installation manual for the installation method of "Media Manager".
- Refer to the user's manual in the installation CD-ROM and Help of "Media Manager" for the operation method of "Media Manager".
- The unit can play CDs (hereafter called "ACDrive disc") created by "Media Manager".
- Refer to the following site for updated information of "Media Manager".
<http://www.kenwood.mediamanager.jp>
- Contact Kenwood for the function and operation of the "Media Manager".
- "Media Manager" is a product of PhatNoise.

The marking of products using lasers (Except for some areas)

**CLASS 1
LASER PRODUCT**

The label is attached to the chassis/case and says that the component uses laser beams that have been classified as Class 1. This means that the unit is utilizing laser beams that are of a weaker class. There is no danger of hazardous radiation outside the unit.

This Product is not installed by the manufacturer of a vehicle on the production line, nor by the professional importer of a vehicle into an EU Member State.

About CDs

Handling CDs

- Do not touch the recording surface of the CD.



- CD-R and CD-RW are easier to damage than a normal music CD. Use a CD-R or a CD-RW after reading the caution items on the package etc.
- Do not stick tape etc. on the CD, or use a CD with tape stuck on it.

When using a new CD

If the CD center hole or outside rim has burrs, use the CD only after removing the burrs with a ballpoint pen, etc.

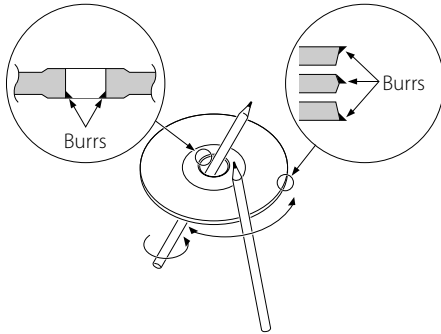

CD accessories

Do not use disc type accessories.

CD cleaning

Clean from the center of the disc and move outward.

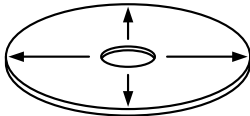

Removing CDs

When removing CDs from this unit pull them out horizontally.

CDs that cannot be used

- CDs that are not round cannot be used.

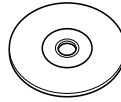

- CDs with coloring on the recording surface or CDs that are dirty cannot be used.
- This unit can only play the CDs with



This unit may not correctly play discs which do not have the mark.

- You cannot play A CD-R or CD-RW that has not been finalized. (For the finalization process refer to your CD-R/CD-RW writing software, and your CD-R/CD-RW recorder instruction manual.)

CD storage

- Do not place CDs in direct sunlight (On the seat or dashboard etc.) or where the temperature is high.
- Store CDs in their cases.

About AAC, MP3 and WMA

The playable AAC/MP3/WMA file (hereafter called Audio file) and the media format has the following limitation. The Audio file, which is not conforming to the specification, may not play normally, or the file and folder names may not display correctly.



- Attach the correct extension for the Audio file (AAC: ".M4A", MP3: ".MP3", WMA: ".WMA")
- Do not attach the extensions to files other than the Audio file. If the extension is attached, the file, which is not the Audio file, will play and outputs a loud noise, causing damage to the speaker.
- The files with copy protection cannot be played.

Playable AAC file

- ".m4a" file encoded by AAC-LC format.
Refer to <http://www.kenwood.mediamanager.jp> for the details.

Playable MP3 file

- MPEG 1/2 Audio Layer 3 file
- Transfer bit rate: 8-320 kbps
- Sampling frequency
KDC-W808: 16, 22.05, 24, 32, 44.1, 48 kHz
KDC-W707: 8, 11.025, 12, 16, 22.05, 24, 32, 44.1, 48 kHz

Playable WMA file

- The file in accordance with Windows Media Audio (Except for the file for Windows Media Player 9 or after which applies the new functions)
- Transfer bit rate: 48-192 kbps
- Sampling frequency: 32, 44.1, 48 kHz

Playable media

- CD-ROM, CD-R, CD-RW



- CD-RW discs which are quick formatted by the writing software cannot be used.
- When recording to the maximum media capacity at once, the writing software is set to "Disc at once".

Playable disc format

- ISO 9660 Level 1/2
- Joliet
- Romeo
- Long file name.

The maximum number of characters for display

File/Folder name:

- KDC-W808: 128 characters
- KDC-W707: 64 characters

MP3 ID3 Tag/ WMA Contents property:
30 characters

AAC song information (KDC-W808 only):
60 characters



- File/Folder name is the number of the characters including the extensions
- MP3 ID3 Tag can only display the tag of Ver1.X. (KDC-W707 only)
- AAC ID3 Tag cannot be displayed.

Limitation of structure for the file and the folder

- Maximum number of directory levels: 8
- Maximum number of folders: 100
- Maximum number of files per folder:
KDC-W808: 4096, KDC-W707: 255

Playing order of the Audio file

The Audio file plays in the order which is written by writing software. You may be able to set the playing order by writing the play sequence numbers such as "01" to "99" at the beginning of the file name.

Example

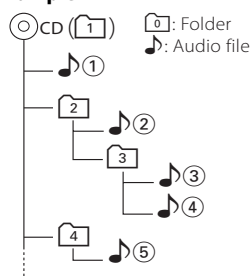

• Playing order

Playing order after ① play.

➡ ②, ③, ④, ⑤...

• File search

Forward file search during ③ play.

Push the Control knob towards ➡ ④

• Folder search

Forward folder search during ② play.

Push the Control knob towards [FM] ➡ ③, ④...

• Folder select

When the selection is set to directory ①, and you want to skip to the folder ② at the same level.

Push the Control knob towards ➡ ②

When the selection is set to directory ③, moves the level up by folder select.

Push the Control knob towards [AM] ➡ ②

General features

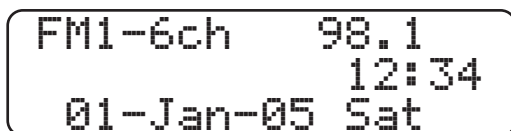
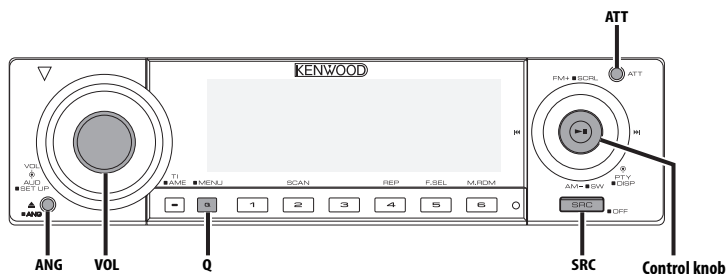

Power

Turning ON the Power

Turn the vehicle ignition ON.

The control panel appears.

Turning OFF the Power

Turn the vehicle ignition OFF or press the [SRC] button for at least 1 second.

The control panel is hidden.



- Do not apply force to the control panel during this operation. It can cause damage.

Hiding the Control Panel

Prevents tampering with the unit while your car is being serviced etc.

Hiding the control panel

Press the [SRC] button for at least 1 second.

When the time set in <OFF Wait Time Setting> (page 33) lapses, the panel is hidden and the power turns OFF.

Showing the control panel

Press the lower left part of the panel.

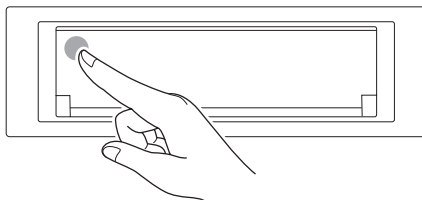

The panel opens to enable the operation.

General features

Selecting the Source

Press the [SRC] button.

Source required	Display
Tuner	"TUNER"
CD	"Compact Disc"
External disc (Optional accessory)	"CD Changer"
Auxiliary input (KDC-W808 only)	"AUX"
Auxiliary input (Optional accessory)	"AUX EXT"
Standby (Illumination only mode)	"STANDBY"



- This unit automatically turns full power OFF after 20 minutes lapses in Standby mode in order to save the vehicle's battery.

The time until full power OFF can be set in <Power OFF Timer> (page 37).

Volume

Increasing Volume

Turn the [VOL] knob clockwise.

Decreasing Volume

Turn the [VOL] knob counterclockwise.

Attenuator

Turning the volume down quickly.

Press the [ATT] button.

Each time you press the button is pressed, the Attenuator turns ON and OFF.

When the Attenuator is ON, "ATT ON" is displayed.

System Q

Selecting the best sound setting preset for different types of music.

1 Select the source to set

Press the [SRC] button.

2 Select the Sound type

Press the [Q] button.

Each time you press the button is pressed, the sound setting alternates.

Sound setting	Display
User memory	"User"
Rock	"Rock"
Pops	"Pops"
Easy	"Easy"
Top 40	"Top 40"
Jazz	"Jazz"
Natural	"Natural"



- User memory: The values set on the <Audio Control> (page 11).
- Change each setting value with the <Speaker Setting> (page 10).
First, select the speaker type with the Speaker setting.

Speaker Setting

Fine-tuning so that the System Q value is optimal when setting the speaker type.

1 Enter Standby

Press the [SRC] button.

Select the "STANDBY" display.

2 Enter Speaker Setting mode

Press the [VOL] knob.

3 Select the Speaker type

Turn the [VOL] knob.

Each time you turn the knob, the setting alternates between the settings shown in the table below.

Speaker type	Display
OFF	"Speaker OFF"
For 5 & 4 in. speaker	"Speaker 5/4inch"
For 6 & 6x9 in. speaker	"Speaker 6x9/6inch"
For the OEM speaker	"Speaker O.E.M."

4 Exit Speaker Setting mode

Press the [VOL] knob.

Audio Control

1 Select the source to adjust

Press the [SRC] button.

2 Enter Audio Control mode

Press the [VOL] knob.

3 Select the Basic Audio item to adjust

Press the [VOL] knob.

Each time you press the knob, the item to be adjusted alternates between the items shown in the table below.

4 Adjust the Basic Audio item

Turn the [VOL] knob.

Adjustment Item	Display	Range
Rear Volume * ¹	"R-Volume"	0 — 35
Subwoofer level* ^{2,3}	"SW_Level"	-15 — +15
Bass level* ⁴	"Bass Level"	-8 — +8
Middle level* ⁴	"Middle Level"	-8 — +8
Treble level* ⁴	"Treble Level"	-8 — +8
Balance	"Balance"	Left 15 — Right 15
Fader* ³	"Fader"	Rear 15 — Front 15

Exit Audio Control mode



- *¹ You can control this item when "2Zone" of <Audio Setup> (page 12) is set to "ON".
- *² You can control this item when <Switching preout> (page 33) is set to "SWPRE:Sub-W". (KDC-W707 only)
- *³ You can control this item when <Subwoofer Output> (page 12) is set to "SW ON".
- *³ You can control this item when "2Zone" of <Audio Setup> (page 12) is set to "OFF".
- *⁴ You can adjust these items in detail by the following methods. (Function of the KDC-W808)
- *⁴ Source tone memory: Puts the set up value in the memory per source. (Detail Audio item is included)

5 Exit Audio Control mode

Press any button.

Press a button other than the [VOL] knob and [ATT]/ [ANG] button.

Adjust the detail of Audio Control

1 Select the Audio item to adjust

By referring to the step 1 — 3 above, select the desired item to be set in detail from the items marked with *⁴.

2 Enter Detail adjustment mode of Audio Control

Press the [VOL] knob for at least 1 second.

3 Select the Detail Audio item to adjust

Press the [VOL] knob.

Each time you press the knob, the item to be adjusted alternates between the items shown in the table below.

4 Adjust the Detail Audio item

Turn the [VOL] knob.

Bass level

Adjustment Item	Display	Range
Bass Center Frequency	"Bass Freq"	40/50/60/70/80/100/120/150 Hz
Bass Q Factor	"Bass Q"	1.00/1.25/1.50/2.00
Bass Extend	"Bass EXT"	ON/OFF

Middle level

Adjustment Item	Display	Range
Middle Center Frequency	"Middle Freq"	0.5/1.0/1.5/2.0 kHz
Middle Q Factor	"Middle Q"	1.0/2.0

Treble level

Adjustment Item	Display	Range
Treble Center Frequency	"Treble Freq"	10.0/12.5/15.0/17.5 kHz

5 Exit the Detail Audio Control mode

Press the [VOL] knob for at least 1 second.



- When you set the Bass Extend to ON, low frequency response is extended by 20%.
- You can exit the Audio Control mode at anytime by pressing any button except for [VOL], [ANG] and [ATT] buttons.

General features

Audio Setup

Setting the Sound system, such as Cross over Network.

1 Select the source to adjust

Press the [SRC] button.

2 Enter Audio Setup mode

Press the [VOL] knob for at least 1 second.

3 Select the Audio Setup item to adjust

Press the [VOL] knob.

Each time you press the knob, the item to be adjusted alternates between the items shown in the table below.

4 Setup the Audio item

Turn the [VOL] knob.

Adjustment Item	Display	Range
Front High Pass Filter*2	"HPF-F"	Through/40/60/80/100/ 120/150/180/220 Hz
Rear High Pass Filter*2	"HPF-R"	Through/40/60/80/100/ 120/150/180/220 Hz
Low Pass Filter*1,2	"LPF"	50/60/80/100/120/Through Hz
Subwoofer Phase*1,2,3	"SW Phase"	Normal (0°) / Reverse (180°)
Volume offset	"VOL Offset"	-8 — ±0
Loudness	"Loudness"	ON/OFF
Dual Zone System	"2Zone"	ON/OFF



- Volume offset: Sets each source's volume as a difference from the basic volume.
- Loudness: Compensates for low and high tones during low volume.
- *1 You can control this item when <Switching preout> (page 33) is set to "SWPRE:Sub-W". (KDC-W707 only)
- *1 You can control this item when <Subwoofer Output> (page 12) is set to "SW ON".
- *2 You can control this item when "2Zone" of <Audio Setup> (page 12) is set to "OFF".
- *3 You can control this item when Low Pass Filter is not set to Through.
- Dual Zone System
Main source and sub source (Auxiliary input) output Front channel and Rear channel separately.
 - Set up the channel of sub source by <Dual Zone System Setting> (page 34).
 - Select Main source by [SRC] button.
 - Adjust the volume of Front channel by [VOL] knob.
 - Adjust the volume of Rear channel by <Audio Control> (page 11).
 - The Audio Control has no effect on sub source.

- You can use the Dual Zone System with the Auxiliary input sources listed below.
 - Internal auxiliary input (KDC-W808 only)
 - Option CA-C1AX (KDC-W707 only)

5 Exit Audio Setup mode

Press [VOL] knob for at least 1 second.

Subwoofer Output

Turning the Subwoofer output ON or OFF.

Hold down on [AM] of the Control knob for at least 1 second.

Each time you press the button, Subwoofer output switches ON and OFF.

When it is ON, "SW ON" is displayed.



- You can control this function when <Switching preout> (page 33) is set to "SWPRE:Sub-W". (KDC-W707 only)
- You can control this function when "2Zone" of <Audio Setup> (page 12) is set to "OFF".

Display Setting

Changing the display mode.

1 Enter display Control mode

Press the Control knob for at least 1 second.

"Display Control" is displayed.

2 Select the Display mode

Press the Control knob.

Each time you press the knob, the display alternates between the display modes shown in the table below.

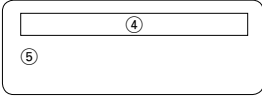
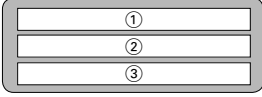
Display Mode	Display
"Display Type A"	
"Display Type B"	
"Display Type C"	

- ① Upper text display part
- ② Middle text display part
- ③ Lower text display part
- ④ Text display part
- ⑤ Graphic display part



- You can display the information that will be shown in the Upper text display part, the Lower text display part or the Level meter display part according to the setting of Display mode. Refer to the following pages for how to select the mode.

Display Type	A	B	C
Upper ①	—	—	page 15
Middle ②	—	—	page 15
Lower ③	—	—	page 15
Text ④	—	page 14	—
Graphic ⑤	page 18	page 18	—

3 Exit Display Control mode

Press the Control knob for at least 1 second.

General features

Display Type B

Text Selection for Display

Selecting the text display.

1 Enter display control mode

Press the Control knob for at least 1 second.

"Display Control" is displayed.

2 Select the display Type

Press the Control knob.

Select the "Display Type B" display.

3 Select the text display part

Push the Control knob towards [FM] or [AM].

The selected text display part blinks.

4 Push the Control knob towards [◀◀] or [▶▶].

Each time you push the knob, the display alternates between the Information displays shown in the tables below.

In Tuner source

Information	Display
Program Service name (FM)	"BAND+ch+PS"*
Radio text (FM)	"Radio Text"*
Frequency (MW, LW)	"BAND+ch+FREQ"
Clock	"Clock"
Date	"Date"

In CD & External disc source

Information	Display
Disc title	"Disc Title"*
Track title	"Track Title"*
Track number & Play time	"P-Time"
Disc name	"DNPS"
Clock	"Clock"
Date	"Date"

In Audio file source

Information	Display
Song title & Artist name	"Title/Artist"*
Album name & Artist name	"Album/Artist"*
Folder name	"Folder Name"
File name	"File Name"
Play time & File number	"P-Time"
Clock	"Clock"
Date	"Date"

In Auxiliary input source

Information	Display
Auxiliary input name	"SRC Name"
Clock	"Clock"
Date	"Date"

In Standby

Information	Display
Standby	"SRC Name"
Clock	"Clock"
Date	"Date"



- * If the contents of the information cannot be displayed, Play time or Frequency is displayed.
- When LX-AMP is connected, the item setup by the Display mode of LX-AMP is displayed.
- Track number at Audio file displays the last 3 digits when the track number exceeds 1000 songs (KDC-W808 only).
- Album name cannot be displayed in WMA file. (KDC-W707 only)
- Song title, Artist name, and Album name cannot be displayed in AAC file. (KDC-W707 only)

5 Exit Display control mode

Press the Control knob for at least 1 second.

Display Type C

Text Display Switching

Changing the text display.

1 Enter display control mode

Press the Control knob for at least 1 second.

"Display Control" is displayed.

2 Select the display Type

Press the Control knob.

Select the "Display Type C" display.

3 Select the text display part

Push the Control knob towards [FM] or [AM].

The selected text display part blinks.

Select the text

Push the Control knob towards [◀◀] or

[▶▶].

Refer to the table described later for setting items.

4 Exit Display Control mode

Press the Control knob for at least 1 second.



- Same information cannot be displayed in Upper text display part, Middle text display part and Lower text display part. However, the blank display is able to have multiple selections.
- When LX-AMP is connected, the item setup by the Display mode of LX-AMP is displayed.
- Track number at Audio file displays the last 3 digits when the track number exceeds 1000 songs (KDC-W808 only).
- Album name cannot be displayed in WMA file. (KDC-W707 only)
- Song title, Artist name, and Album name cannot be displayed in AAC file. (KDC-W707 only)

General features

The text display in the Upper text display part

In Tuner source

Information	Display
Program Service name (FM)	"BAND+ch+PS"*
Radio text (FM)	"Radio Text"
Frequency (MW, LW)	"BAND+ch+FREQ"
Spectrum Analyzer & Clock	"Speana/Clock"
Date	"Date"

Displaying the frequency during Program Service name reception

Press the [SCRL] button for at least 1 second.

The frequency for the RDS station will be displayed for 5 seconds instead of the Program Service name.

In CD & External disc source

Information	Display
Disc title	"Disc Title"*
Track title	"Track Title"*
Track number & Play time	"P-Time"
Disc name	"DNPS"
Spectrum Analyzer & Clock	"Speana/Clock"
Date	"Date"

In Audio file source

Information	Display
Song title & Artist name	"Title/Artist"*
Album name & Artist name	"Album/Artist"*
Folder name	"Folder Name"
File name	"File Name"
Play time & File number	"P-Time"
Spectrum Analyzer & Clock	"Speana/Clock"
Date	"Date"

In Standby

Information	Display
Standby	"SRC Name"
Clock	"Clock"
Date	"Date"

In Auxiliary input source

Information	Display
Auxiliary input name	"SRC Name"
Spectrum Analyzer & Clock	"Speana/Clock"
Date	"Date"



- * If the contents of the information cannot be displayed, Play time or Frequency is displayed.

The text display in the Middle text display part

In Tuner source

Information	Display
Spectrum Analyzer & Clock	"Speana/Clock"
Date	"Date"
Blank	"Blank"
Radio text (FM)	"Radio Text"

In CD & External disc source

Information	Display
Spectrum Analyzer & Clock	"Speana/Clock"
Date	"Date"
Blank	"Blank"
Disc title	"Disc Title"*
Track title	"Track Title"*
Disc name	"DNPS"

In Audio file source

Information	Display
Spectrum Analyzer & Clock	"Speana/Clock"
Date	"Date"
Blank	"Blank"
Song title & Artist name	"Title/Artist"*
Album name & Artist name	"Album/Artist"*
Folder name	"Folder Name"
File name	"File Name"

In Standby

Information	Display
Clock	"Clock"
Date	"Date"
Blank	"Blank"

In Auxiliary input source

Information	Display
Spectrum Analyzer & Clock	"Speana/Clock"
Date	"Date"
Blank	"Blank"



- * If the contents of the information cannot be displayed, Kenwood Logo is displayed.

General features

The text display in the Lower text display part

In Tuner source

Information	Display
Indicator	"Indicator"
Spectrum Analyzer & Clock	"Speana/Clock"
Date	"Date"
Blank	"Blank"
Radio text (FM)	"Radio Text"

In CD & External disc source

Information	Display
Indicator	"Indicator"
Spectrum Analyzer & Clock	"Speana/Clock"
Date	"Date"
Blank	"Blank"
Disc title	"Disc Title"*
Track title	"Track Title"*
Disc name	"DNPS"

In Audio file source

Information	Display
Indicator	"Indicator"
Spectrum Analyzer & Clock	"Speana/Clock"
Date	"Date"
Blank	"Blank"
Song title & Artist name	"Title/Artist"*
Album name & Artist name	"Album/Artist"*
Folder name	"Folder Name"
File name	"File Name"

In Standby

Information	Display
Indicator	"Indicator"
Clock	"Clock"
Date	"Date"
Blank	"Blank"

In Auxiliary input source

Information	Display
Indicator	"Indicator"
Spectrum Analyzer & Clock	"Speana/Clock"
Date	"Date"
Blank	"Blank"



- * If the contents of the information cannot be displayed, indicator is displayed.

Display Type A/ Display Type B

Graphic part/ Spectrum Analyzer Display Switching

Changing the graphic Display/ Spectrum analyzer display.

1 Enter display control mode

Press the Control knob for at least 1 second.

"Display Control" is displayed.

2 Select the display Type

Press the Control knob.

Select the "Display Type A"/ "Display Type B" display.

3 Select the graphic/ spectrum analyzer display ("Display Type B" only)

Push the Control knob towards [FM] or [AM].

The blinking text display part stops.

4 Select the graphic/ spectrum analyzer display part display

Push the Control knob towards [◀◀] or [▶▶].

Each time you push the knob, the display alternates between the display names shown in the table below.

Graphic display/ Spectrum Analyzer display

Wallpaper 1 – 5

Spectrum analyzer 1 – 5

5 Exit Display control mode

Press the Control knob for at least 1 second.

Faceplate Angle Adjustment

Press the [ANG] button for at least 1 second.



- Do not apply excessive force to the faceplate. It can cause damage.

Theft Deterrent Faceplate

The faceplate of the unit can be detached and taken with you, helping to deter theft.

Removing the Faceplate

1 Turn the ignition OFF or press the [SRC] button for at least 1 second.

The power turns OFF and the faceplate slides open.

2 Holding the center part of the faceplate pull it out.

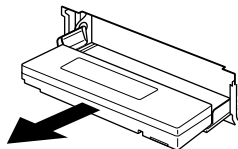

- When the faceplate is kept remove open, according to the <OFF Wait Time Setting> (page 33) setting, the faceplate is hidden and the power turns OFF.
- The faceplate is a precision piece of equipment and can be damaged by shocks or jolts. For that reason, keep the faceplate in its special storage case while detached.
- Do not expose the faceplate or its storage case to direct sunlight or excessive heat or humidity. Also avoid places with too much dust or the possibility of water splashing.

Reattaching the Faceplate

1 Set the left side of the faceplate in the faceplate bracket.

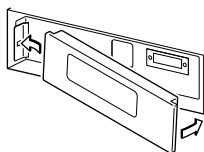

2 Press the right side of the faceplate until it locks.



- Use the enclosed or dedicated faceplate. Using a faceplate other than the specified one may cause your unit to malfunction.

TEL Mute

The audio system automatically mutes when a call comes in.

When a call comes in

"CALL" is displayed.

The audio system pauses.

Listening to the audio during a call

Press the [SRC] button.

The "CALL" display disappears and the audio system comes back ON.

When the call ends

Hang up the phone.

The "CALL" display disappears and the audio system comes back ON.

Tuner features

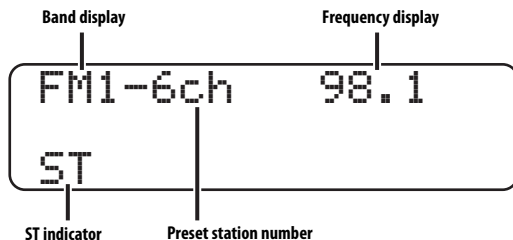
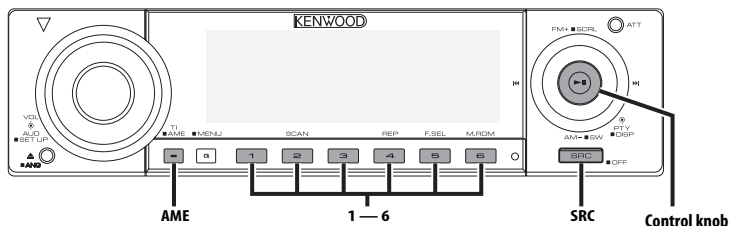

Tuning

Selecting the station.

1 Select tuner source

Press the [SRC] button.

Select the "TUNER" display.

2 Select the band

Push the Control knob towards [FM] or [AM].

Each time you push the knob toward [FM], it switches between the FM1, FM2, and FM3 bands.

3 Tune up or down band

Push the Control knob towards [◀◀] or [▶▶].



- During reception of stereo stations the "ST" indicator is ON.

Station Preset Memory

Putting a station in the memory.

1 Select the band

Push the Control knob towards [FM] or [AM].

2 Select the frequency to put in the memory

Push the Control knob towards [◀◀] or [▶▶].

3 Put the frequency in the memory

Press the desired [1] — [6] button for at least 2 seconds.

The preset number display blinks 1 time.

On each band, 1 station can be put in the memory on each [1] — [6] button.

Auto Memory Entry

Putting stations with good reception in the memory automatically.

1 Select the band for Auto Memory Entry

Push the Control knob towards [FM] or [AM].

2 Open Auto Memory Entry

Press the [AME] button for at least 2 seconds.

When 6 stations that can be received are put in the memory Auto Memory Entry closes.



- When the <AF (Alternative Frequency)> (page 35) is ON, only RDS stations are put in the memory.
- When Auto Memory Entry is done in the FM2 band, the RDS stations preset in the FM1 band are not put in the memory.

Likewise, when Auto Memory Entry is done in the FM3 band, RDS stations preset in FM1 or FM2 are not put in the memory.

Preset Tuning

Recalling the stations in the memory.

1 Select the band

Push the Control knob towards [FM] or [AM].

2 Recall the station

Press the desired [1] — [6] button.

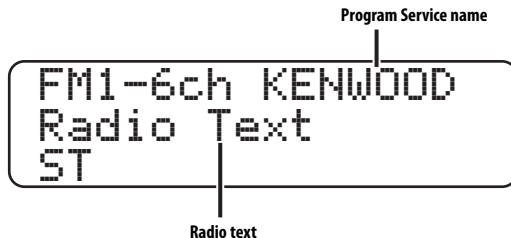
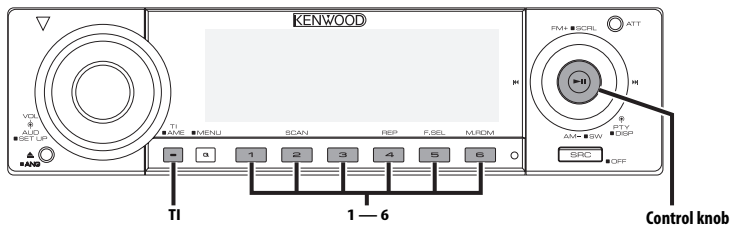

Traffic Information

Changing to traffic information automatically when a traffic bulletin starts even when you are not listening to the radio.

Press the [TI] button.

Each time you press the button, the Traffic information function turns ON and OFF. When traffic information is ON, "Traffic INFO ON" is displayed.

When a traffic information station is not being received the "TI" indicator blinks.

When a traffic bulletin starts, "Traffic INFO" is displayed and the audio changes to traffic information.



- During reception of an AM station when the Traffic Information function is turned ON, the frequency changes to an FM station.
- During reception of traffic information the adjusted volume is automatically remembered, and the next time the audio changes to traffic information, the volume automatically becomes the remembered volume.

Receiving other traffic information stations

Push the Control knob towards [◀▶] or [▶▶].



- Traffic information can be switched when it is on the Tuner Source. However, you cannot switch the Traffic information during reception of the Traffic bulletin switched from the source other than the Tuner.

Radio Text Scroll

Scrolling the displayed radio text.

Hold down on [FM] of the Control knob for at least 1 second.

PTY (Program Type)

Selecting the Program Type and searching for a station.

1 Enter PTY mode

Press the Control knob.

"PTY Select" is displayed.



- This function cannot be used during a traffic bulletin or AM reception.

2 Select the Program Type

Push the Control knob towards [FM] or [AM].

Each time you push the knob, the Program Type alternates between the program types shown in the table below.

No.	Program Type	Display
1.	Speech	"All Speech"
2.	Music	"All Music"
3.	News	"News"
4.	Current Affairs	"Current Affairs"
5.	Information	"Information"
6.	Sport	"Sport"
7.	Education	"Education"
8.	Drama	"Drama"
9.	Culture	"Cultures"
10.	Science	"Science"
11.	Varied	"Varied Speech"
12.	Pop Music	"Pop Music"
13.	Rock Music	"Rock Music"
14.	Easy Listening Music	"Easy Listening M"
15.	Light Classical	"Light Classic M"
16.	Serious Classical	"Serious Classic"
17.	Other Music	"Other Music"
18.	Weather	"Weather&Metr"
19.	Finance	"Finance"
20.	Children's programs	"Children's prog"
21.	Social Affairs	"Social Affairs"
22.	Religion	"Religion"
23.	Phone In	"Phone In"
24.	Travel	"Travel&Touring"
25.	Leisure	"Leisure&Hobby"
26.	Jazz Music	"Jazz Music"
27.	Country Music	"Country Music"
28.	National Music	"National Music"
29.	Oldies Music	"Oldies Music"
30.	Folk Music	"Folk Music"
31.	Documentary	"Documentary"



- Speech and Music include the Program type shown below.
Music: No.12 — 17, 26 — 30
Speech: No.3 — 11, 18 — 25, 31
- You can put the Program Type in the [1] — [6] button memory and for quick recall. Refer to the <Program Type preset> (page 23).
- You can change the display language. Refer to <Changing Language for PTY Function> (page 24).

3 Search for the selected Program Type station

Push the Control knob towards [◀◀] or [▶▶].

When you want to search for other stations, push [◀◀] or [▶▶] of the Control knob again.



- When the selected Program Type is not found, "No PTY" is displayed. Select another Program Type.

4 Exit PTY mode

Press the Control knob.

Program Type preset

Putting the Program Type in the Preset button memory and quick recall.

Presetting the Program Type

1 Select the Program Type to preset

Refer to <PTY (Program Type)> (page 23).

2 Preset the Program Type

Press the desired [1] — [6] button for at least 2 seconds.

Recalling the preset Program Type

1 Enter PTY mode

Refer to <PTY (Program Type)> (page 23).

2 Recall the Program Type

Press the desired [1] — [6] button.

Changing Language for PTY Function

Selecting the Program Type display language.

1 Enter PTY mode

Refer to <PTY (Program Type)> (page 23).

2 Enter Changing Language mode Press the [TI] button.

3 Select the language

Push the Control knob towards [FM] or [AM].

Each time you push the knob, the language alternates between the languages shown in the table below.

Language	Display
English	"English"
Spanish	"Spanish"
French	"French"
Dutch	"Dutch"
Norwegian	"Norwegian"
Portuguese	"Portuguese"
Swedish	"Swedish"
German	"German"

4 Exit Changing Language mode Press the [TI] button.

CD/Audio file/External disc control features

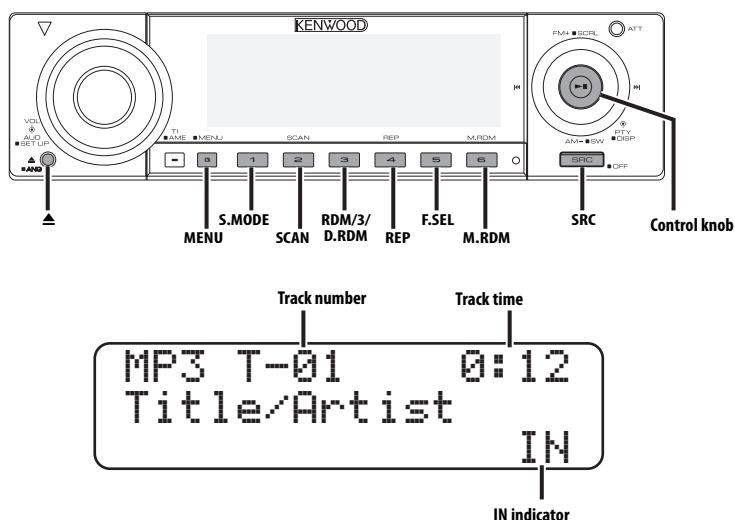

Playing CD & Audio file

When there is no disc inserted

- 1 Open the panel
Press the [**▲**] button.
- 2 Insert a disc.



- When the faceplate slides open, it might interfere with the shift lever or other vehicle function. If this happens, pay attention to safety and move the shift lever or take an appropriate action to remove the obstacle, then operate the unit.
- Insert the disc horizontal to the slot. If you insert the Disc as you push down on the Disc, it may scratch the Disc.



- The sound will be temporarily muted while the faceplate is moving.
- Refer to <About AAC, MP3 and WMA> (page 8) for the Audio file by models you can play.
- You can cancel the announcement when selecting the folder by <Voice Index> (page 37) during the play of the ACDrive. (KDC-W808 only)
- When a disc is inserted the "IN" indicator is ON.

When a disc is inserted

- Press the [SRC] button.
Select the "Compact Disc" display.

Pause and play

- Press the Control knob.
Each time you press the knob, the audio pauses or plays.

Eject the disc

- 1 Eject the disc
Press the [**▲**] button.
- 2 Return the panel to the original position
Press the [**▲**] button.

CD/Audio file/External disc control features

Playing External Disc

Playing discs set in the optional accessory disc player connected to this unit.

Press the [SRC] button.

Select the display for the disc player you want.

Display examples:

Display	Disc player
"CD Changer"	CD changer
"MD Changer"	MD changer

Pause and play

Press the Control knob.

Each time you press the knob, the audio pauses or plays.



- The functions that can be used and the information that can be displayed will differ depending on the external disc players being connected.

Fast Forwarding and Reversing

Fast Forwarding

Hold down toward [▶▶] with the Control knob.

Release your finger to play the disc at that point.

Reversing

Hold down toward [◀◀] with the Control knob.

Release your finger to play the disc at that point.



- There is no sound while the Audio file is being searched.
- You cannot fast Forwarding and Reversing while AAC file is being played. (KDC-W707 only)
- You cannot fast Forwarding and Reversing depending on AAC file format. (KDC-W808 only)

Track/File Search

Searching for a song on the disc or in the Audio file folder.

Push the Control knob towards [◀◀] or

[▶▶].



- If the remote control with number buttons is used as optional accessories, you can directly select a song you want to listen to with the operation below.
 1. Enter a track/file number.
Press the number buttons on the remote control.
 2. Do the Track/File Search.
Push the Control knob towards [◀◀] or [▶▶].

Function of disc changer/ Audio file

Disc Search/Folder Search

Selecting the disc set in the Disc changer or the folder recorded on the Audio file media.

Push the Control knob towards [FM] or [AM].

Track/File/Disc/Folder Repeat

Replaying the song, disc in the Disc changer or Audio file folder you are listening to.

Press the [REP] button.

Each time you press the button, the Repeat Play alternates between the modes shown in the tables below.

In CD & External disc source

Repeat play	Display
Track Repeat	"Repeat ON"/ "Track Repeat ON"
Disc Repeat (In Disc Changer)	"Disc Repeat ON"
OFF	"Repeat OFF"

In Audio file

Repeat play	Display
File Repeat	"File Repeat ON"
Folder Repeat	"Folder Repeat ON"
OFF	"Repeat OFF"

Scan Play

Playing the first part of each song on the disc or Audio file folder you are listening to and searching for the song you want to hear.

1 Start Scan Play

Press the [SCAN] button.

"Scan ON" is displayed.

2 Release the button when the song you want to hear is played

Press the [SCAN] button.

Random Play

Play all the songs on the disc or Audio file folder in random order.

Press the [RDM] button.

Each time you press the button, Random Play turns ON or OFF.

When the Random mode is ON, "Random ON" is displayed.



- When you push the Control knob toward [▶▶], the next random song starts.

Function of disc changer

Magazine Random Play

Play the songs on all the discs in the disc changer in random order.

Press the [M.RDM] button.

Each time you press the button, the Magazine Random Play turns ON or OFF.

When the Magazine Random mode is ON, "Magazine RDM ON" is displayed.



- When you push the Control knob toward [▶▶], the next random song starts.

Function of the KDC-W808

Function of Audio file

Disc Random Play

Playing randomly from all of the Audio files recorded in the disc.

Press the [RDM] button for at least 1 second.

When the random mode is ON, "Disc Random ON" is displayed.

Canceling the Disc Random Play

Press the [RDM] button.



- When you push the Control knob toward [▶▶], the next random song starts.

CD/Audio file/External disc control features

Function of Audio file

Folder Select

Quickly selecting the folder you want to hear.

1 Enter Folder Select mode

Press the [F.SEL] button.

"Select Mode" is displayed.

During Select mode the folder information is displayed as shown below.

Folder number display

Displays the number in the folder belonging to the currently selected folder.

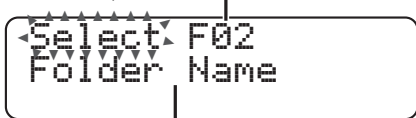

Folder name display

Displays the current folder name.



- The Folder number display does not function when <Disc Random Play> (page 27) is ON.

2 Select the folder level*

Push the Control knob towards [FM] or [AM].

With the [FM] of the Control knob, you move 1 level down and with the [AM] of the Control knob, 1 level up.

Selecting a folder in the same level

Push the Control knob towards [◀◀] or [▶▶].

With the [◀◀] of the Control knob, you move to the previous folder, and with the [▶▶] of the Control knob, to the next folder.

Returning to the top level*

Press the [3] button.



- * You can operate this function when <Switching the Play mode> (page 28) is set to "Folder Mode" while playing ACDrive disc. (KDC-W808 only)

3 Decide the folder to play

Press the Control knob.

The Folder Select mode releases, and the Audio file in the folder being displayed plays.

Cancelling the Folder Select mode

Press the [F.SEL] button.

Function of the KDC-W808

Function of ACDrive disc

Switching the Play mode

Arrange the playing orders of the songs by categories.

Press the [S.MODE] button.

Each time you press the button, the Play mode alternates between the modes shown on the table below.

Play mode	Category which is to be arranged
"PlayList Mode"	Play list order.
"Genre Mode"	By genre.
"Artist Mode"	By artist.
"Album Mode"	By album.
"Folder Mode"	By the folder recorded in Disc.



- The category information of each song is the data registered in Media Manager when ACDrive disc is being generated.
- You can cancel the announcement made when the mode is changed by <Voice Index> (page 37).
- You can select the advancement of the Play mode information by [AM] and [FM] keys.

Function of the KDC-W808

Function of ACDrive disc

Letter Seek

You can search for the song, you want to play, by selecting the initial of Genre name, Artist name, or Album name.

1 Enter the Letter Seek mode

Press the [S.MODE] button for at least 1 second.



- This operation does not function when <Disc Random Play> (page 27) is ON.
- This function is available only when the Play mode is set Genre, Artist, or Album.

Cancelling the Letter Seek

Press the [S.MODE] button.

2 Start the Letter Seek

Push the Control knob towards [◀◀] or [▶▶].

The initial of Genre name, Artist name, or Album name is displayed and announced in order.



- The announcement of the initial can be canceled by <Voice Index> (page37).
- When you push the Control knob to the reverse [◀◀] or [▶▶] during Letter Seek, the initial is displayed and announced in the reversed order.
- Once Letter Seek starts, it cannot be cancelled.

3 Select the song to play

Press the Control knob when the initial of the song you are searching is displayed and announced.

The selected initial group plays.

Disc Naming (DNPS)

Attaching a title to a CD.

1 Play the disc you want to attach a name to



- A title cannot be attached to MD or Audio file media.

2 Enter Menu mode

Press the [MENU] button for at least 1 second.

"Menu" is displayed.

3 Select Name set mode

Push the Control knob towards [FM] or [AM].

Select the "Name Set" display.

4 Enter Name set mode

Press the Control knob for at least 1 second.

5 Move the cursor to the enter character position

Push the Control knob towards [◀◀] or [▶▶].

6 Select the character type

Press the Control knob.

Each time you press the knob, the character type alternates between the types shown in the table below.

Character type

Alphabet upper case

Alphabet lower case

Numbers and symbols

Special characters (Accent characters)

7 Select the characters

Push the Control knob towards [FM] or [AM].

8 Repeat steps 5 through 7 and enter the name.

9 Exit Menu mode

Press the [MENU] button.



- When operation stops for 10 seconds the name at that time is registered, and Name Set mode closes.
- Media that you can attach a name to
 - Internal CD player: 10 discs.
 - External CD changer/ player: Varies according to the CD changer/ player. Refer to the CD changer/ player manual.
- You can change the name of a CD by the same operation you used to name it.

Text/Title Scroll

Scrolling the displayed CD text, Audio file text, or MD title.

Push the Control knob toward [FM] for at least 1 second.

Menu system

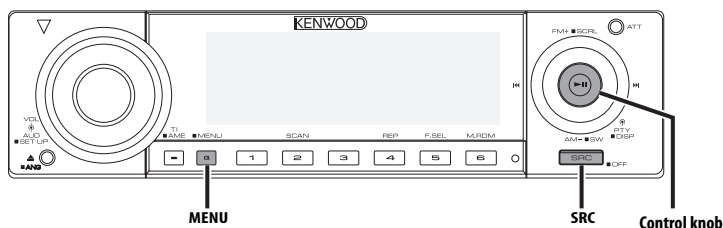

Clock Adjust
Beep: ON
Security

Menu System

Setting beep sound during operation, etc. functions.

The Menu system basic operation method is explained here. The reference for the Menu items and their setting content is after this operation explanation.

1 Enter Menu mode

Press the [MENU] button for at least 1 second.

"Menu" is displayed.

2 Select the menu item

Push the Control knob towards [FM] or [AM].

Example: When you want to set the beep sound select the "Beep" display.

3 Set the menu item

Push the Control knob towards [◀◀] or [▶▶].

Example: When you select "Beep", each time you push the knob it alternates between "Beep:ON" or "Beep:OFF". Select 1 of them as the setting.

You can continue by returning to step 2 and setting other items.

4 Exit Menu mode

Press the [MENU] button.



- When other items those applicable to the basic operation method above are displayed, their setting content chart is entered. (Normally the setting listed at the top of the chart is the original setting.) Also, the explanation for items that are not applicable (<Manual Clock Adjustment> etc.) are entered step by step.
- Three menu items appear on the display. The menu item displayed at the center is the one you can adjust.

Menu system

In Standby mode

Security Code

Because authorization by the Security Code is required when the audio unit is removed from the vehicle, personalizing this unit by using the Security Code is helpful in preventing theft.



- Setup Security Code when the <Demonstration mode Setting> (page 39) is set as OFF.
- When you activate the Security Code function, it cannot be released.
Note, your Security Code is the 4 digit number entered in your "Car Audio Passport" in this package.

1 Enter Standby

Press the [SRC] button.

Select the "STANDBY" display.

2 Enter Menu mode

Press the [MENU] button for at least 1 second.

When "Menu" is displayed, "Security" is displayed.

3 Enter Security Code mode

Press the Control knob for at least 1 second.

When "Enter" is displayed, "CODE" is also displayed.

4 Select the digits to enter

Push the Control knob towards [◀◀] or [▶▶].

5 Select the Security Code numbers

Push the Control knob towards [FM] or [AM].

6 Repeat steps 4 and 5, and complete the Security Code.

7 Confirm the Security Code

Press the Control knob for at least 3 seconds.

When "Re-Enter" is displayed, "CODE" is also displayed.

8 Do the step 4 through 7 step operation, and reenter the security code.

"Approved" is displayed.

The Security Code function activates.



- If you enter a Code different from your Security Code, you have to start over from step 4.

Press the Reset button when the audio unit is removed from the battery power source

1 Turn the power ON.

2 Do the step 4 through 7 step operation, and reenter the security code.

"Approved" is displayed.

You can begin using the unit.



- If an incorrect code is entered, "WAITING" is displayed, and the input prohibition periods shown in the table below is generated.
After the input prohibition time lapses, "CODE" is displayed, and you can reenter the code.

Number of times the incorrect code was input	Input prohibited time
1	—
2	5 minutes
3	1 hour
4	24 hours

In Standby mode

Touch Sensor Tone

Setting the operation check sound (beep sound) ON/OFF.

Display	Setting
"Beep:ON"	Beep is heard.
"Beep:OFF"	Beep canceled.

In Standby mode

Manual Clock Adjustment



- You can do this adjustment when the <Synchronize Clock> (page 33) is set as OFF.

1 Select Clock Adjustment mode

Push the Control knob towards [FM] or [AM].

Select the "Clock Adjust" display.

2 Enter Clock Adjust mode

Press the Control knob for at least 1 second.

The clock display blinks.

3 Adjust the hours

Push the Control knob towards [FM] or [AM].

Adjust the minutes

Push the Control knob towards [◀◀] or [▶▶].

4 Exit Clock adjustment mode

Press the [MENU] button.

In Standby mode

Date Adjustment

1 Select Date Adjust mode

Push the knob towards [FM] or [AM].

Select the "Date Adjust" display.

2 Enter Date Adjust mode

Press the Control knob for at least 1 second.

The date display blinks.

3 Selecting the item (day, month, or year) to adjust

Push the Control knob towards [◀◀] or [▶▶].

The items that are blinking are items that you can adjust.

4 Adjust each item

Push the Control knob towards [FM] or [AM].

5 Repeat step 3 and 4 operation and adjust the date.

6 Exit Date adjustment mode

Press the [MENU] button.

In Standby mode

Date Mode

Setting the date format.

1 Select Date Mode

Push the Control knob towards [FM] or [AM].

Select the "Date Mode" display.

2 Select the date format

Push the Control knob towards [◀◀] or [▶▶].

3 Exit Date mode

Push the Control knob towards [FM] or [AM].

In Standby mode

Synchronize Clock

Synchronizing the RDS station time data and this unit's clock.

Display	Setting
"SYNC:ON"	Synchronizes the time.
"SYNC:OFF"	Adjust the time manually.



- It takes 3 to 4 minutes to synchronize the clock.

In Standby mode

Dimmer

Dimming this unit's display automatically when the vehicle light switch is turned ON.

Display	Setting
"Dimmer:ON"	The display dims.
"Dimmer:OFF"	The display doesn't dim.

In Standby mode

OFF Wait Time Setting

Setting the time until the faceplate hiding operation starts after the power is turned OFF. You can only remove the faceplate during the set time period.

Display and Setting
"Off Wait:0sec"
:
"Off Wait:3sec" (Original setting)
:
"Off Wait:25sec"

Function of the KDC-W707

In Standby mode

Switching preout

Alternating the preout between the rear and subwoofer. (With the subwoofer the sound outputs without being effected by fader control.)

Display	Setting
"SWPRE:Rear"	Rear preout.
"SWPRE:Sub-W"	Subwoofer preout.

Menu system

In Standby mode

Built-in Amp Setting

Controlling the built-in amplifier.
Turning OFF this control enhances the preout quality.

Display	Setting
"AMP:ON"	The built-in amplifier activates.
"AMP:OFF"	The built-in amplifier deactivates.

Other than Standby mode/
When the Dual Zone System is ON

Dual Zone System Setting

Setting the Front channel and Rear channel sound in the Dual Zone System.

Display	Setting
"Zone2:Rear"	Sub source (Auxiliary input source) is to be rear channel.
"Zone2:Front"	Sub source (Auxiliary input source) is to be front channel.

Other than Standby mode

B.M.S. (Bass Management System)

Adjust the bass boost level of the external amplifier using the main unit.

Display	Setting
"AMP Bass:Flat"	Bass boost level is flat.
"AMP Bass:+6"	Bass boost level is low (+6dB).
"AMP Bass:+12"	Bass boost level is mid (+12dB).
"AMP Bass:+18"	Bass boost level is high (+18dB).



- Refer to the catalog or instruction manual for power amplifiers that can be controlled from this unit.
- For amplifiers, there are the models you can set from Flat to +18 dB, and the models you can set from Flat to +12 dB.

When an amplifier that can only be set to +12 is connected to the unit, "AMP Bass:+18" will not work correctly even if it is selected.

Other than Standby mode

B.M.S. Frequency Offset

Setting the central frequency, boosted by B.M.S.

Display	Setting
"AMP FREQ:Normal"	Boost with the normal central frequency.
"AMP FREQ:Low"	Drop the normal central frequency 20%.

When LX AMP unit connecting

AMP Control

You can control the LX AMP connected to the unit.

- Select AMP Control mode**
Push the Control knob towards [FM] or [AM].
Select the "AMP Control" display.
- Enter AMP Control mode**
Press the Control knob for at least 1 second.
- Select the AMP Control item for adjustment**
Push the Control knob towards [FM] or [AM].



- For the details on the AMP Control item, see the Instruction manual attached to the LX AMP.

- Adjust the AMP Control item**
Push the Control knob towards [◀◀◀] or [▶▶▶].
- Exit AMP Control mode**
Press the [MENU] button.



- You cannot use the LX AMP operation during standby mode.

News Bulletin with Timeout Setting

The tuner automatically changes when a news bulletin starts even if the radio is not being listened to. Also, you can set the time interval when interruption is prohibited.

Display and Setting
"News:OFF"
"News:00min"
⋮
"News:90min"

When you set "News:00min" — "News:90min", the News Bulletin Interrupt function is ON. When the News Bulletin is ON, the "News" indicator is ON.

When the news bulletin starts, "News" is displayed, and the tuner changes to the news bulletin.



- If you choose the "20min" setting, further news bulletins will not be received for 20 minutes once the first news bulletin is received.
- The news bulletin volume is the same level that was set for <Traffic Information> (page 22).
- This news bulletin function is only available if the desired station sends PTY-code for news bulletin or belongs to <Enhanced Other Network>-Network sending PTY-code for news bulletin.
- When the News Bulletin Interrupt function is ON, the tuner changes to an FM station.

In Tuner mode

Local Seek

Only stations whose reception is good are searched in auto seek tuning.

Display	Setting
"Local Seek:OFF"	The local seek function is OFF.
"Local Seek:ON"	The local seek function is ON.

In Tuner mode

Tuning Mode

Sets the tuning mode.

Tuning mode	Display	Operation
Auto seek	"Seek Mode: Auto1"	Automatic search for a station.
Preset station seek	"Seek Mode: Auto2"	Search in order of the stations in the Preset memory.
Manual	"Seek Mode: Manual"	Normal manual tuning control.

In FM reception

AF (Alternative Frequency)

When the reception is poor, automatically alternate to another frequency broadcasting the same program in the same RDS network with better reception.

Display	Setting
"AF:ON"	The AF function is ON.
"AF:OFF"	The AF function is OFF.

When the AF function is ON, the "RDS" indicator is ON.



- When no other stations with stronger reception are available for the same program in the RDS network, you may hear the incoming broadcast in bits and snatches. Turn OFF the AF function in such a case.

In FM reception

Restricting RDS Region (Region Restrict Function)

You can choose whether or not to restrict the RDS channels, received with the AF function for a particular network, to a specific region.

Display	Setting
"Regional:ON"	The Region Restrict Function is ON.
"Regional:OFF"	The Region Restrict Function is OFF.



- If AF function is not restricted to the specified region and network, the AF function sets up to search the station with good reception in the same RDS network.

In FM reception

Auto TP Seek

When the TI function is ON and the reception is poor when listening to a traffic information station, another traffic information station with better reception will be searched for automatically.

Display	Setting
"Auto TP Seek:ON"	The Auto TP Seek Function is ON.
"Auto TP Seek:OFF"	The Auto TP Seek Function is OFF.

Menu system

In FM reception

Monaural Reception

You can reduce the noise when stereo broadcasts are received as monaural.

Display	Setting
"MONO:OFF"	The monaural reception is OFF.
"MONO:ON"	The monaural reception is ON.

External Display Control

Changing the display of the External Display connected to this unit.

Display
"OEM Display Out"

Each time you push the knob towards [◀◀] or [▶▶], the display switches.

Auxiliary Input Display Setting & Disc Naming

Selecting the display when alternating to Auxiliary input source. For the Disc Naming refer to the <Disc Naming (DNPS)> (page 29).

1 Select Auxiliary input source

Press the [SRC] button.

Select the "AUX"/ "AUX EXT" display.

2 Enter Menu mode

Press the [MENU] button for at least 1 second.

"Menu" is displayed.

3 Select Auxiliary input display setting mode

Push the Control knob towards [FM] or [AM].

Select the "Name Set" display.

4 Enter Auxiliary input display setting mode

Press the Control knob for at least 1 second.

The selected Auxiliary input display is displayed.

5 Select the Auxiliary input display

Push the Control knob towards [◀◀] or [▶▶].

Each time you press the button, the display alternates as listed below.

- "AUX"/ "AUX EXT"
- "DVD"

- "PORTABLE"
- "GAME"
- "VIDEO"
- "TV"

6 Exit Auxiliary input display setting mode

Press the [MENU] button.



- When operation stops for 10 seconds, the name at that time is registered, and the Auxiliary input display setting mode closes.
- The Auxiliary Input Display can be set only when the built-in auxiliary input or the auxiliary input of optional KCA-S210A is used.

Text Scroll

Setting the displayed text scroll.

Display	Setting
"Scroll:Manual"	Doesn't scroll.
"Scroll:Auto"	Scrolls when the display changes.



- The text scrolled is listed below.
 - CD text
 - Folder name/ File name/ Song title/ Artist name/ Album name
 - MD title
 - Radio text

Function of the KDC-W808

In Standby mode

Built-in Auxiliary input Setting

Set the Built-in Auxiliary Input function.

Display	Setting
"Builtin AUX:OFF"	When selecting the source there's no Auxiliary Input.
"Builtin AUX:ON"	When selecting the source there's Auxiliary Input.

In Standby mode

Power OFF Timer

Setting the timer to turn this unit's power OFF automatically when Standby mode continues. Using this setting can save the vehicle's battery power.

Display	Setting
"Power OFF :-- --"	Power OFF Timer function is OFF.
"Power OFF :20min" (Original setting)	Turns the power OFF after 20 minutes.
"Power OFF :40min"	Turns the power OFF after 40 minutes.
"Power OFF :60min"	Turns the power OFF after 60 minutes.



- Do this setting after setting <Security Code> (page 32).

In Standby mode

CD Read Setting

When there is a problem with playing a CD with special format, this setting plays the CD by force.

Display	Setting
"CD Read:1"	Play CD and Audio file.
"CD Read:2"	Play CD by force.



- Setting "CD Read:2" cannot play Audio file.
Some music CDs may not play even in the "CD Read:2" mode.

Function of the KDC-W808

Function of ACDrive disc

Voice Index

Setting the announcement during the play of ACDrive disc.

Display	Setting
"Voice Index:ON"	Guide is announced.
"Voice Index:OFF"	Not be announced.

Function of the KDC-W808

In CD mode

ACDrive firmware version display

Displaying the firmware version with the ACDrive function.

1 Select the firmware version display mode

Push the Control knob towards [FM] or [AM].
Select the "ACD F/W Version" display.

2 Display the ACDrive firmware version

Push the Control knob towards [◀◀] or [▶▶].

Function of the KDC-W808

In CD mode

Unique ID display

Displaying the serial number for each product.

1 Select the unique ID display mode

Push the Control knob towards [FM] or [AM].
Select the "ACD Unique ID" display.

2 Display the unique ID

Push the Control knob towards [◀◀] or [▶▶].

Audio Preset Memory

Registering the value setup by Sound Control. The memory cannot be erased by the Reset button.

1 Setup Sound Control

Refer to the following operations to setup the Sound Control.

- <Audio Control> (page 11)
- <Audio Setup> (page 12)

2 Enter Menu mode

Press the [MENU] button for at least 1 second. "Menu" is displayed.

3 Select Audio Preset mode

Push the Control knob towards [FM] or [AM]. Select the "Audio Preset" display.

4 Enter Audio Preset mode

Press the Control knob for at least 1 second.

5 Select the Audio Preset Memory

Push the Control knob towards [FM] or [AM]. Select the "Memory" display.

6 Put the Audio Preset in the memory

Press the Control knob for at least 2 seconds. The "Memory" display blinks 1 time.

7 Exit Menu mode

Press the [MENU] button.



- Register 1 pair of Audio Preset Memory. You cannot register by the source.
- When you press the Reset, all the sources will be the setting value which is registered.
- The following items cannot be registered. Volume, Balance, Fader, Loudness, Volume offset, Dual Zone System, Rear Volume

Audio Preset Call

Recalling the sound setup registered by <Audio Preset Memory> (page 38).

1 Select the source

Press the [SRC] button.

2 Enter Menu mode

Press the [MENU] button for at least 1 second. "Menu" is displayed.

3 Select Audio Preset mode

Push the Control knob towards [FM] or [AM]. Select the "Audio Preset" display.

4 Enter Audio Preset mode

Press the Control knob for at least 1 second.

5 Select the Audio Preset Recall

Push the Control knob towards [FM] or [AM]. Select the "Recall" display.

6 Recall the Audio Preset

Press the Control knob for at least 2 seconds. The "Recall" display blinks 1 time.

7 Exit Menu mode

Press the [MENU] button.



- The User memory of <System Q> (page 10) is changed to the value which was recalled.
- The source tone memory item of <Audio Control> (page 11) is changed to the value which was recalled by the selected source.

*Function of the KDC-W707 (Russian sales area)
In Standby mode*

Selecting Russian Characters

Select Russian as a text display language.

Display	Setting
"Russian:ON"	Displays texts using Russian characters.
"Russian:OFF"	Displays texts using European characters.



- Texts displayed using Russian characters are as follows.
 - Folder name/ File name/ Song title/ Artist name/ Album name

In Standby mode

Demonstration mode Setting

Sets the demonstration mode.

1 Select the Demonstration mode

Push the Control knob towards [FM] or [AM].

Select the "DEMO Mode" display.

2 Set the Demonstration mode

Press the Control knob for at least 2 seconds.

Each time you press the knob at least 2 seconds, the Demonstration mode alternates between the settings shown in the table below.

Display	Setting
"DEMO Mode:ON"	The Demonstration mode function is ON.
"DEMO Mode:OFF"	Exit Demonstration mode (Normal mode).

Accessories/ Installation Procedure

Accessories

①

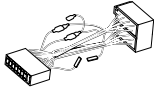

.....1

②

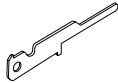

.....2

③



.....1

④

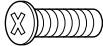

.....1

⑤



.....1

Installation Procedure

1. To prevent short circuits, remove the key from the ignition and disconnect the ⊖ terminal of the battery.
2. Make the proper input and output wire connections for each unit.
3. Connect the wire on the wiring harness.
4. Take Connector B on the wiring harness and connect it to the speaker connector in your vehicle.
5. Take Connector A on the wiring harness and connect it to the external power connector on your vehicle.
6. Connect the wiring harness connector to the unit.
7. Install the unit in your car.
8. Reconnect the ⊖ terminal of the battery.
9. Press the reset button.



- If your car is not prepared for this special connection-system, consult your Kenwood dealer.
- Only use antenna conversion adapters (ISO-JASO) when the antenna cord has an ISO plug.
- Make sure that all wire connections are securely made by inserting jacks until they lock completely.
- If your vehicle's ignition does not have an ACC position, or if the ignition wire is connected to a power source with constant voltage such as a battery wire, the power will not be linked with the ignition (i.e., it will not turn on and off along with the ignition). If you want to link the unit's power with the ignition, connect the ignition wire to a power source that can be turned on and off with the ignition key.
- If the fuse blows, first make sure that the wires have not caused a short circuit, then replace the old fuse with one with the same rating.
- Insulate unconnected wires with vinyl tape or other similar material. To prevent short circuits, also do not remove the caps on the ends of the unconnected wires or the terminals.
- Connect the speaker wires correctly to the terminals to which they correspond. The unit may receive damage or fail to work if you share the ⊖ wires and/or ground them to any metal part in the car.
- After the unit is installed, check whether the brake lamps, indicators, wipers, etc. on the car are working properly.
- If the console has a lid, make sure to install the unit so that the faceplate does not hit the lid when closing and opening.
- Mount the unit so that the mounting angle is 30° or less.

Connecting Wires to Terminals

	KDC-W808		KDC-W707
A	Front left output (White)	"FRONT"	Front left output (White)
	Front right output (Red)		Front right output (Red)
B	Rear left output (White)	"	—
	Rear right output (Red)		—
C	Sub Woofer left output (White)	"	—
	Sub Woofer right output (Red)		—
D	AUX left input (White)	"REAR"/ "SUB WOOFER"	Rear left output (White)/ Sub Woofer left output (White)
	AUX right input (Red)		Rear right output (Red)/ Sub Woofer right output (Red)

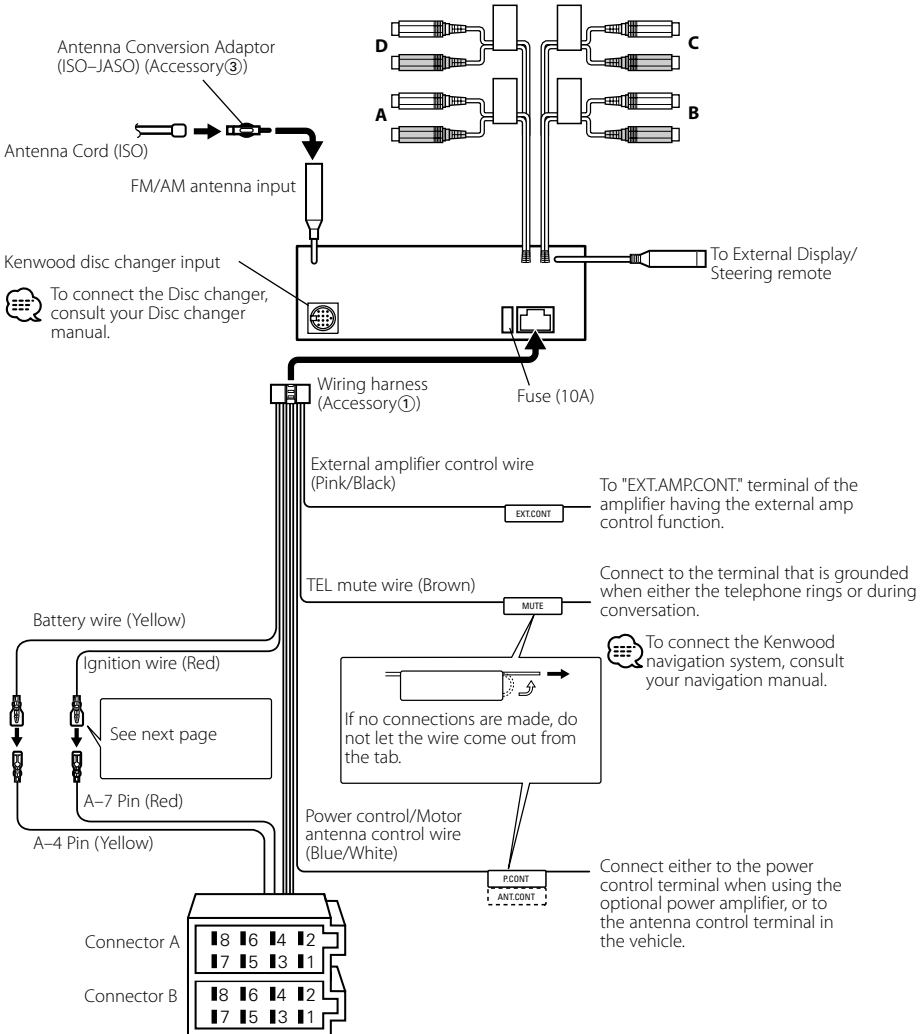

Connecting Wires to Terminals

Connector Function Guide

Pin Numbers for ISO Connectors	Cable Colour	Functions
External Power Connector		
A-4	Yellow	Battery
A-5	Blue/White	Power Control
A-6	Orange/White	Dimmer
A-7	Red	Ignition (ACC)
A-8	Black	Earth (Ground) Connection
Speaker Connector		
B-1	Purple	Rear Right (+)
B-2	Purple/Black	Rear Right (-)
B-3	Gray	Front Right (+)
B-4	Gray/Black	Front Right (-)
B-5	White	Front Left (+)
B-6	White/Black	Front Left (-)
B-7	Green	Rear Left (+)
B-8	Green/Black	Rear Left (-)

▲WARNING

Connecting the ISO Connector

The pin arrangement for the ISO connectors depends on the type of vehicle you drive. Make sure to make the proper connections to prevent damage to the unit. The default connection for the wiring harness is described in [1] below. If the ISO connector pins are set as described in [2] or [3], make the connection as illustrated. Please be sure to reconnect the cable as shown [2] below to install this unit to the **Volkswagen** vehicles etc.

[1] (Default setting) The A-7 pin (red) of the vehicle's ISO connector is linked with the ignition, and the A-4 pin (yellow) is connected to the constant power supply.

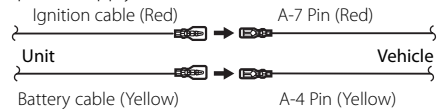

[2] The A-7 pin (red) of the vehicle's ISO connector is connected to the constant power supply, and the A-4 pin (yellow) is linked to the ignition.

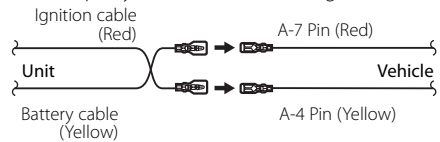

[3] The A-4 pin (yellow) of the vehicle's ISO connector is not connected to anything, while the A-7 pin (red) is connected to the constant power supply (or both the A-7 (red) and A-4 (yellow) pins are connected to the constant power supply).

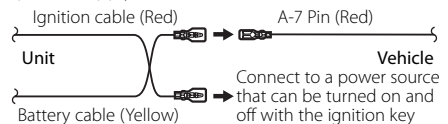

Installation

Installation

Metal mounting strap
(commercially available)

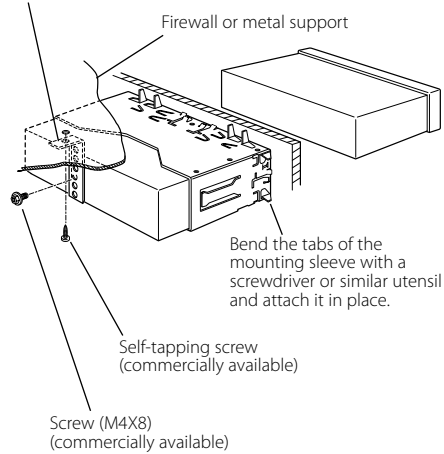

- Make sure that the unit is installed securely in place. If the unit is unstable, it may malfunction (for example, the sound may skip).

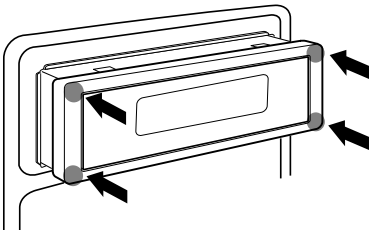

- To attach this unit, make sure the front of the control panel faces you and fit it into the mounting sleeve by pressing the four corners of the hard rubber frame at the same time. Do not apply strong pressure to other sections than the corners; otherwise troubles such as the impossibility of opening or closing the panel may result.

Screwing the Faceplate on the Unit

If you want to fasten the faceplate to the main unit so that it does not fall off, screw in the provided screws in the holes shown below.

- 1 Refer to the function <Theft Deterrent Faceplate> (page 19) and remove the faceplate.
- 2 Insert the provided screw into the hole at the center of the bottom side of the faceplate which you have removed from the unit.

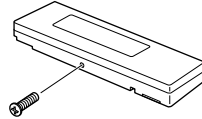

Accessory④

- 3 Refer to the section <Theft Deterrent Faceplate> (page 19) and then reattaching the faceplate.



- Never insert the screw in any other screw hole than the one specified. If you screw them in another hole, it will contact and may cause damage to the mechanical parts inside the unit.

Removing the Unit

Removing the hard rubber frame

Insert the removal tool into the indentations in the hard rubber frame, and pull it gently until the lock is released.

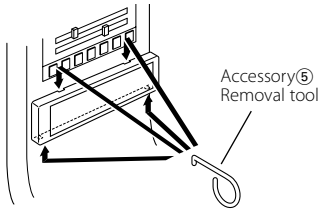

Removing the Unit

- 1 Refer to the section <Removing the hard rubber frame> (page 44) and then remove the hard rubber frame.
- 2 Remove the screw (M4 × 8) on the back panel.
- 3 Insert the two removal tools deeply into the slots on each side, as shown.

Screw (M4X8)
(commercially available)

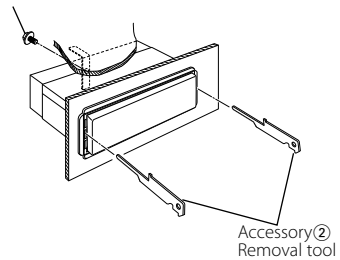

- 4 Push upward the removal tool toward the top, and pull out the unit halfway while pressing towards the inside.

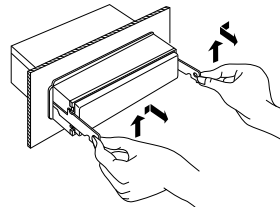

- Be careful to avoid injury from the catch pins on the removal tool.
- 5 Pull the unit all the way out with your hands, being careful not to drop it.

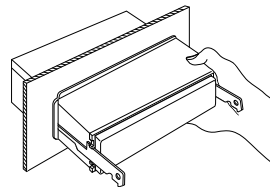

Troubleshooting Guide

What might seem to be a malfunction in your unit may just be the result of slight misoperation or miswiring. Before calling service, first check the following table for possible problems.

General

? The power does not turn ON.

- ✓ The fuse has blown.
 - ☞ After checking for short circuits in the wires, replace the fuse with one with the same rating.

? There's a source you can't switch.

- ✓ There's no media inserted.
 - ☞ Set the media you want to listen to. If there's no media in this unit, you can't switch to each source.
- ✓ The Disc changer isn't connected.
 - ☞ Connect the Disc changer. If the Disc changer isn't connected to its input terminal, You can't switch to an external disc source.

? The memory is erased when the ignition is turned OFF.

- ✓ The ignition and battery wire are incorrectly connected.
 - ☞ Connect the wire correctly, referring to the section on <Connecting Wires to Terminals>.

? There's no loudness effect.

- ✓ You're using Subwoofer preout.
 - ☞ Loudness has no effect in Subwoofer preout.

? The TEL mute function does not work.

- ✓ The TEL mute wire is not connected properly.
 - ☞ Connect the wire correctly, referring to the section on <Connecting Wires to Terminals>.

? The TEL mute function turns ON even though the TEL mute wire is not connected.

- ✓ The TEL mute wire is touching a metal part of the car.
 - ☞ Pull the TEL mute wire away from the metal part of the car.

? Even if Loudness is turned ON, high-pitched tone isn't compensated for.

- ✓ Tuner source is selected.
 - ☞ High-pitched tone isn't compensated for when in Tuner source.

? No sound can be heard, or the volume is low.

- ✓ The fader or balance settings are set all the way to one side.
 - ☞ Center the fader and balance settings.
- ✓ The input/output wires or wiring harness are connected incorrectly.
 - ☞ Reconnect the input/output wires or the wiring harness correctly. See the section on <Connecting Wires to Terminals>.
- ✓ The values of Volume offset are low.
 - ☞ Turn up the Volume offset, referring to the section on <Audio Control> (page 11).
- ✓ The <Built-in Amp Setting> (page 34) is OFF.
 - ☞ Turn it ON.

? The sound quality is poor or distorted.

- ✓ One of the speaker wires is being pinched by a screw in the car.
 - ☞ Check the speaker wiring.
- ✓ The speakers are not wired correctly.
 - ☞ Reconnect the speaker wires so that each output terminal is connected to a different speaker.

? The Touch Sensor Tone doesn't sound.

- ✓ The preout jack is being used.
 - ☞ The Touch Sensor Tone can't be output from the preout jack.

? Even though Synchronize Clock is ON, the clock can't be adjusted.

- ✓ The received RDS station isn't sending time data.
 - ☞ Receive another RDS station.

? The Dimmer function doesn't work.

- ✓ The Dimmer wire isn't connected correctly.
 - ☞ Check the Dimmer wire connection.
- ✓ The <Dimmer> (page 33) is OFF.
 - ☞ Turn it ON.

? The panel is not hidden even when the power is turned off.

- ✓ The protection function for preventing fingers or other things from getting caught in between the panel and this unit has been activated.
 - ☞ Turn off the power again.

? The sound is not output from Subwoofer or it outputs the different sound.

- ✓ When "2Zone" of <Audio Setup> (page12) is set to ON.
 - ☞ Turn OFF "2Zone" of <Audio Setup>.

? Cannot display the Russian characters.

- ✓ ---
 - ☞ Refer to <Selecting Russian Characters> (page 38).

Troubleshooting Guide

Tuner source

? Radio reception is poor.

- ✓ The car antenna is not extended.
☞ Pull the antenna out all the way.
- ✓ The antenna control wire is not connected.
☞ Connect the wire correctly, referring to the section on <Connecting Wires to Terminals>.

? It isn't the set Traffic information sound volume.

- ✓ The set sound volume is less than the tuner sound volume.
☞ If the tuner sound volume is louder than the set sound volume, the tuner sound volume is used.

Disc source

? "AUX EXT" is displayed without achieving External disc control mode.

- ✓ Unsupported disc changer is connected.
☞ Use the disc changer mentioned in the <About CD players/disc changers connected to this unit> (page 4) of the section on <Safety precautions>.

? The specified disc does not play, but another one plays instead.

- ✓ The specified CD is quite dirty.
☞ Clean the CD.
- ✓ The disc is loaded in a different slot from that specified.
☞ Eject the disc magazine and check the number for the specified disc.
- ✓ The disc is severely scratched.
☞ Try another disc instead.

? A CD ejects as soon as it is loaded.

- ✓ The CD is quite dirty.
☞ Clean the CD, referring to the CD cleaning of the section on <About CDs> (page 7).

? Can't remove disc.

- ✓ The cause is that more than 10 minutes has elapsed since the vehicle ACC switch was turned OFF.
☞ The disc can only be removed within 10 minutes of the ACC switch being turned OFF. If more than 10 minutes has elapsed, turn the ACC switch ON again and press the Eject button.

? The disc won't insert.

- ✓ There's already another disc inserted.
☞ Press the [▲] button and remove the disc.

? Direct Search can't be done.

- ✓ Another function is ON.
☞ Turn Random Play or other functions OFF.

? Track Search can't be done.

- ✓ For the discs/folders first or last song.
☞ For each disc/folder, Track Search cannot be done in the backward direction for the first song or in the forward direction for the last song.

Audio file source

? Cannot play an Audio file.

- ✓ The media is scratched or dirty.
☞ Clean the media, referring to the CD cleaning of the section on <About CDs> (page 7).

? The sound skips when an Audio file is being played.

- ✓ The media is scratched or dirty.
☞ Clean the media, referring to the CD cleaning of the section on <About CDs> (page 7).
- ✓ The recording condition is bad.
☞ Record the media again or use another media.

? The Audio file track time isn't displayed correctly.

- ✓ ---
☞ There are times when it isn't displayed correctly according to the Audio file recording conditions.

The messages shown below display your systems condition.

Eject:	No disc magazine has been loaded in the changer. The disc magazine is not completely loaded. ↔ Load the disc magazine properly. No CD in the unit. ↔ Insert the CD.
No Disc:	No disc has been loaded in the disc magazine. ↔ Load a disc into the disc magazine.
TOC Error:	No disc has been loaded in the disc magazine. ↔ Load a disc into the disc magazine. The CD is quite dirty. The CD is upside-down. The CD is scratched a lot. ↔ Clean the CD and load it correctly.
E-05:	The CD is upside-down. ↔ Load the CD correctly.
Blank Disc:	Nothing has been recorded on the MD.
No Track Disc:	No tracks are recorded on the MD, although it has a title.
E-15:	Media was played that doesn't have data recorded that the unit can play. ↔ Use media that has data recorded that the unit can play.
No Music Data:	Media was played that doesn't have data recorded that the unit can play. ↔ Use media that has data recorded that the unit can play. Files for picture downloading only are recorded in CD-R/CD-RW.
No Panel:	The faceplate of the slave unit being connected to this unit has been removed. ↔ Replace it.
E-77:	The unit is malfunctioning for some reason. ↔ Press the reset button on the unit. If the "E-77" code does not disappear, consult your nearest service center.
Mecha Error:	Something is wrong with the disc magazine. Or the unit is malfunctioning for some reason. ↔ Check the disc magazine. And then press the reset button on the unit. If the "Mecha Error" code does not disappear, consult your nearest service center.

Hold Error:	The protective circuit in the unit activates when the temperature inside the automatic disc changer exceeds 60°C (140°F), stopping all operation. ↔ Cool down the unit by opening the windows or turning on the air conditioner. As the temperature falls below 60°C (140°F), the disc will start playing again.
No Name:	Attempted to display DNPS during the CD play having no disc names preset.
WAITING:	Radio text data is being received.
Load:	Discs are being exchanged in the Disc changer.
READING:	The unit is reading the data on the disc.
IN (Blink):	The CD player section is not operating properly. ↔ Reinsert the CD. If the CD cannot be ejected or the display continues to flash even when the CD has been properly reinserted, please switch off the power and consult your nearest service center.
Unsupported File:	An Audio file is played with a format that this unit can't support. ↔ ----
Copy Protection:	A copy-protected file is played. ↔ ----
DEMO:	The Demonstration mode has been selected. ↔ The <Demonstration mode Setting> (page 39) is ON. Turn it OFF.
PROTECT:	The speaker wire has a short-circuit or touches the chassis of the vehicle, and then the protection function is activated. ↔ Wire or insulate the speaker cable properly and press the reset button.

Specifications

Specifications subject to change without notice.

FM tuner section

Frequency range (50 kHz space)
: 87.5 MHz – 108.0 MHz
Usable sensitivity (S/N = 26dB)
: 0.7 μ V/75 Ω
Quieting Sensitivity (S/N = 46dB)
: 2.5 μ V/75 Ω
Frequency response (\pm 3.0 dB)
: 30 Hz – 15 kHz
Signal to Noise ratio (MONO)
: 65 dB
Selectivity (DIN) (\pm 400 kHz)
: \geq 80 dB
Stereo separation (1 kHz)
: 35 dB

MW tuner section

Frequency range (9 kHz space)
: 531 kHz – 1611 kHz
Usable sensitivity (S/N = 20dB)
: 28 μ V

LW tuner section

Frequency range
: 153 kHz – 281 kHz
Usable sensitivity (S/N = 20dB)
: 45 μ V

CD player section

Laser diode
: GaAlAs
Digital filter (D/A)
: 8 Times Over Sampling
D/A Converter
: 1 Bit
Spindle speed (Audio file)
: 1000 – 400 rpm (CLV 2times)
Wow & Flutter
: Below Measurable Limit
Frequency response (\pm 1 dB)
: 10 Hz – 20 kHz
Total harmonic distortion (1 kHz)
: 0.008 %
Signal to Noise ratio (1 kHz)
KDC-W808: 110 dB
KDC-W707: 105 dB
Dynamic range
: 93 dB
Channel separation
: 96 dB

MP3 decode
: Compliant with MPEG-1/2 Audio Layer-3
WMA decode
: Compliant with Windows Media Audio
AAC decode
: AAC-LC ".m4a" files

Audio section

Maximum output power
: 50 W x 4
Output power (DIN 45324, +B=14.4V)
: 30 W x 4
Tone action
Bass : 100 Hz \pm 8 dB
Middle : 1 kHz \pm 8 dB
Treble : 10 kHz \pm 8 dB
Preout level / Load (during disc play)
KDC-W808: 5000 mV/10 k Ω
KDC-W707: 2000 mV/10 k Ω
Preout impedance (during disc play)
: \leq 80 Ω

Auxiliary input (KDC-W808)

Frequency response (\pm 1 dB)
: 20 Hz – 20 kHz
Input Maximum Voltage
: 1200 mV
Input Impedance
: 100 k Ω

General

Operating voltage (11 – 16V allowable)
: 14.4 V
Current consumption
: 10 A
Installation Size (W x H x D)
: 182 x 53 x 162 mm
Weight
: 1.40 kg