

# KENWOOD

CD-RECEIVER

**KDC-W3541**

**KDC-W3041**

**KDC-W312**

**KDC-W241**

**KDC-241**

---

## INSTRUCTION MANUAL

Kenwood Corporation



© B64-4065-00/00 (EO/E20)



# Contents

<b>Before use</b>	<b>3</b>	<b>Appendix</b>	<b>13</b>
<b>Basic Operation</b>	<b>4</b>	<b>Accessories/ Installation Procedure</b>	<b>15</b>
General functions		<b>Connecting Wires to Terminals</b>	<b>16</b>
Tuner functions		<b>Installation/Removing the Unit</b>	<b>18</b>
Disc play functions		<b>Troubleshooting Guide</b>	<b>19</b>
<b>General Operation</b>	<b>6</b>	<b>Specifications</b>	<b>20</b>
Audio Control			
Audio Setup			
Speaker Setting			
Switching Display			
<b>Tuner Operation</b>	<b>8</b>		
PTY (Program Type)			
Program Type preset			
Changing Language for PTY Function			
<b>Music disc/Audio file Operation</b>	<b>9</b>		
Folder Select			
<b>Menu Operation</b>	<b>10</b>		
Menu System			
Security Code			
Manual Clock Adjustment			
Auxiliary Input Display Setting			
Demonstration mode Setting			

## Before use

### **▲WARNING**

#### **To prevent injury or fire, take the following precautions:**

- To prevent a short circuit, never put or leave any metallic objects (such as coins or metal tools) inside the unit.

#### **Before using this unit for the first time**

This unit is initially set on the Demonstration mode. When using this unit for the first time, cancel the <Demonstration mode Setting> (page 12).

#### **How to reset your unit**

- If the unit fails to operate properly, press the Reset button. The unit returns to factory settings when the Reset button is pressed.
- Press the reset button if the disc auto changer fails to operate correctly. Normal operation should be restored.

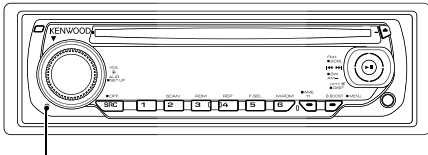

Reset button

#### **Cleaning the Unit**

If the faceplate of this unit is stained, wipe it with a dry soft cloth such as a silicon cloth. If the faceplate is stained badly, wipe the stain off with a cloth moistened with neutral cleaner, then wipe it again with a clean soft dry cloth.



- Applying spray cleaner directly to the unit may affect its mechanical parts. Wiping the faceplate with a hard cloth or using a volatile liquid such as thinner or alcohol may scratch the surface or erase characters.

#### **Cleaning the Faceplate Terminals**

If the terminals on the unit or faceplate get dirty, wipe them with a clean soft dry cloth.

#### **Lens Fogging**

When you turn on the car heater in cold weather, dew or condensation may form on the lens in the CD player of the unit. Called lens fogging, this condensation on the lens may not allow CDs to play. In such a situation, remove the disc and wait for the condensation to evaporate. If the unit still does not operate normally after a while, consult your Kenwood dealer.

- If you experience problems during installation, consult your Kenwood dealer.
- When you purchase optional accessories, check with your Kenwood dealer to make sure that they work with your model and in your area.
- The characters which can be displayed by this unit are A-Z 0-9 @ " ' % & \* + - = , . / \ < > [ ] ( ) ; : ^ - { } | ~ .
- The RDS feature won't work where the service is not supported by any broadcasting station.
- The illustrations of the display and the panel appearing in this manual are examples used to explain more clearly how the controls are used. Therefore, what appears on the display in the illustrations may differ from what appears on the display on the actual equipment, and some of the illustrations on the display may be inapplicable.

#### **Handling CDs**

- Do not touch the recording surface of the CD.
- Do not stick tape etc. on the CD, or use a CD with tape stuck on it.
- Do not use disc type accessories.
- Clean from the center of the disc and move outward.
- When removing CDs from this unit, pull them out horizontally.
- If the CD center hole or outside rim has burrs, use the CD only after removing the burrs with a ballpoint pen etc.

#### **CDs that cannot be used**

- CDs that are not round cannot be used.

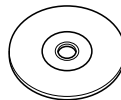

- CDs with coloring on the recording surface or CDs that are dirty cannot be used.

- This unit can only play the CDs with 

This unit may not correctly play discs which do not have the mark.

- You cannot play a CD-R or CD-RW that has not been finalized. (For the finalization process refer to your CD-R/CD-RW writing software, and your CD-R/CD-RW recorder instruction manual.)

# Basic Operation

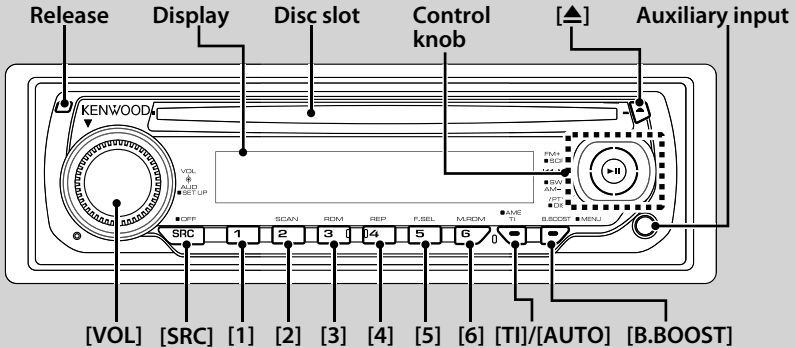

## General functions

### Power/Source select button [SRC]

Turns on the power.

When the power is on, the source switches between Tuner ("TUNER"), CD ("CD"), Auxiliary input ("AUX"), and Standby ("STANDBY") each time this button is pressed.

Press at least 1 second to turn off the power.



- When an optional accessory is connected, the source name for each device appears (KDC-W3541 only).

### Volume control [VOL]

### Bass boost [B.BOOST]

Switches between Boost 1 ("BB-L L1"), Boost 2 ("BB-L L2"), and Boost off ("BB-L OFF") each time this button is pressed.

### Faceplate release Release

Releases the faceplate lock so that it can be removed. Refer to the following diagram when reattaching the faceplate.

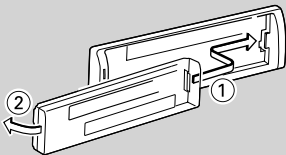

- The faceplate is a precision piece of equipment and can be damaged by shocks or jolts.
- Keep the faceplate in its faceplate case while detached.
- Do not place the faceplate (and the faceplate case) in areas exposed to direct sunlight, excessive heat or humidity. Also avoid places with too much dust or the possibility of water

splashing.

- To prevent deterioration, do not touch the terminals of the unit or faceplate with your fingers.

### Auxiliary input Auxiliary input

Connect a portable audio device with mini-plug cable (3.5  $\phi$ ).



- Use the mini-plug cable which is stereo type and does not have any resistance.

### Muting volume upon reception of phone call

When there is a call, "CALL" is displayed and the audio system is paused.

When the call ends, "CALL" disappears and the audio system comes back on.

The audio system comes back on when [SRC] is pressed during a call.

### Subwoofer output (KDC-W3541/KDC-W3041/

### KDC-W312) Control knob

Switches between ON ("SW ON") and OFF ("SW OFF") each time the bottom side is pressed for at least 2 seconds.

### Text/Title scroll (KDC-W3541/KDC-W3041/

### KDC-W312/KDC-W241) Control knob

Scrolls the CD, audio file, and Radio text display when pressing the top side for at least 2 seconds.



: Indicates the button etc. to operate.

## Tuner functions

### Band select Control knob

Switches between FM1, FM2, and FM3 each time the top side is pressed.

Switches to AM when the bottom side is pressed.

### Tuning Control knob

Changes the frequency when the left or right side is pressed.



- During reception of stereo stations the "ST" indicator is ON.

### Traffic information (KDC-W3541/KDC-W3041/

### KDC-W312/KDC-241) [TI]

Turns ON or OFF the Traffic Information function.

When the function is turned ON, "TI" indicator is ON. If traffic bulletin starts when the function is ON, "TRAFFIC" is displayed and traffic information is received.



- If the volume is adjusted during reception of traffic information, the adjusted volume is memorized automatically. The memorized volume will be applied next time the Traffic Information function is turned ON.

### Tuning mode select (KDC-W241) [AUTO]

Switches the Tuning mode each time this button is pressed. Refer to "AUTO1, AUTO2, MANUAL" of <Appendix> (page 13).

### Preset memory [1] - [6]

Memorize the station selected when pressing for at least 2 seconds.

### Auto memory entry [TI]/ [AUTO]

Memorizes six stations with good reception automatically when pressed for at least 2 seconds.

### Preset tuning [1] - [6]

Recalls the memorized station.

## Disc play functions

### Disc play Disc slot

Starts playing when a disc is inserted.

When a CD is inserted, the "IN" indicator is ON.



- 3 inch CD cannot be used. Attempt to insert using an adapter can cause malfunction.

- Refer to <About Audio file> (page 13) for the Audio file by models you can play.

### Pause and play Control knob

Switches between pause and play each time the center is pressed.

### Disc ejection [▲]



- You can eject the disc for 10 minutes after switching off the engine.

### Music search Control knob

Changes the music when the left or right side is pressed.

Fast reverses or forwards the music while pressing the left or right side.

### Folder/Disc search (KDC-W3541/KDC-W3041/

### KDC-W312/KDC-W241) Control knob

Switches the folder containing the audio file or the disc in the disc changer when pressing the top or bottom side.

### Track/ File/ Disc/ Folder repeat play [4]

Switches between Track Repeat ("TRAC REP"), Disc Repeat ("DISC REP") (In Disc Changer), and OFF ("REP OFF") when pressed while playing a CD.

Switches between File Repeat ("FILE REP"), Folder Repeat ("FOLD REP"), and OFF ("REP OFF") when pressed while playing an audio file.

### Scan play [2]

Successively plays the intro of the music in the disc or folder.

"TRAC SCN"/ "FILE SCN" is displayed during Scan Play.

### Random play [3]

Randomly plays the music in the disc or folder.

"DISC RDM"/ "FOLD RDM" is displayed during Random Play.

### Magazine random play (KDC-W3541) [6]

Randomly plays the music in the disc changer.

"MGZN RDM" is displayed during Magazine Random Play.

# General Operation

## Audio Control

### 1 Select the source to adjust

Press the [SRC] button.

### 2 Enter Audio Control mode

Press the [VOL] knob.

### 3 Select the Audio item to adjust

Press the [VOL] knob.

Adjustment Item	Display	Range
Subwoofer level*	"SW L"	-15 — +15
System Q	"NATURAL"/ "ROCK"/"POPS"/ "EASY"/"TOP40"/ "JAZZ"/"USER"	Natural/Rock/Pops/Easy/Top 40/Jazz/User setting
Bass level	"BAS L"	-8 — +8
Middle level	"MID L"	-8 — +8
Treble level	"TRE L"	-8 — +8
Balance	"BAL"	Left 15 — Right 15
Fader	"FAD"	Rear 15 — Front 15

*Exit Audio Control mode (Volume control mode)*

\*Function of KDC-W3541/W3041/W312.



- "USER": This appears when Bass level, Middle level, and Treble level are adjusted.

### 4 Adjust the Audio item

Turn the [VOL] knob.

### 5 Exit Audio Control mode

Press any button.

Press a button other than the [VOL] knob.

## Audio Setup

Setting the Sound system.

### 1 Select the source to adjust

Press the [SRC] button.

### 2 Enter Audio Setup mode

Press the [VOL] knob for at least 1 second.

### 3 Select the Audio Setup item to adjust

Press the [VOL] knob.

Adjustment Item	Display	Range
Low Pass Filter*	"LPF"	80/120/160/Through Hz
Volume offset	"V-OFF"	-8 — ±0 (AUX: -8 — +8)

\*Function of KDC-W3541/W3041/W312.



- Volume offset: Sets each source's volume as a difference from the basic volume.

### 4 Adjust the Audio setup item

Turn the [VOL] knob.

### 5 Exit Audio Setup mode

Press the [VOL] knob for at least 1 second.

## Speaker Setting

Fine-tuning so that the System Q value is optimal when setting the speaker type.

### 1 Enter Standby

Press the [SRC] button.

Select the "STANDBY" display.

### 2 Enter Speaker Setting mode

Press the [VOL] knob.

### 3 Select the Speaker type

Turn the [VOL] knob.

Speaker type	Display
OFF	"SP OFF"
For 5 & 4 in. speaker	"SP 5/4"
For 6 & 6x9 in. speaker	"SP 6*9/6"
For the OEM speaker	"SP OEM"

### 4 Exit Speaker Setting mode

Press the [VOL] knob.

## Switching Display

Changing the information displayed.

### 1 Enter Switching Display mode

Press the center of the Control knob for at least 1 second.

"DISP SEL" is displayed.

### 2 Select the Display item

Press the right or left side of the Control knob.

### In Tuner source

Information	Display
Program Service name or Frequency	"FREQ"/"FREQ/PS"
Radio text, Program Service name or Frequency*	"R-TEXT"
Clock	"CLOCK"

\* This is not displayed on the KDC-W241/KDC-241.

### **In CD & External disc source**

<b>Information</b>	<b>Display</b>
Disc title*	"D-TITLE"
Track title*	"T-TITLE"
Play time & Track number	"P-TIME"
Clock	"CLOCK"

\* This is not displayed on the KDC-241.

### **In Audio file source**

<b>Information</b>	<b>Display</b>
Music title & Artist name	"TITLE"
Album name & Artist name	"ALBUM"
Folder name	"FOLDER"
File name	"FILE"
Play time & Music number	"P-TIME"
Clock	"CLOCK"

### **In Standby/ Auxiliary input source**

<b>Information</b>	<b>Display</b>
Source name	"SRC NAME"
Clock	"CLOCK"

## **3 Exit Switching Display mode**

**Press the center of the Control knob.**



- When you select the clock display, the display setting of each source will be changed to the clock display.
- Album name cannot be displayed in WMA file.
- If the selected display item does not have any information, alternative information is displayed.

## Tuner Operation

### PTY (Program Type)

Selecting the Program Type and searching for a station.

#### 1 Enter PTY mode

Press the center of the Control knob.

During PTY mode the "PTY" indicator is ON.



- This function cannot be used during a traffic bulletin or AM reception.

#### 2 Select the Program Type

Press the top or bottom side of the Control knob.

No.	Program Type	Display
1.	Speech	"SPEECH"
2.	Music	"MUSIC"
3.	News	"NEWS"
4.	Current Affairs	"AFFAIRS"
5.	Information	"INFO"
6.	Sport	"SPORT"
7.	Education	"EDUCATE"
8.	Drama	"DRAMA"
9.	Culture	"CULTURE"
10.	Science	"SCIENCE"
11.	Varied	"VARIED"
12.	Pop Music	"POP M"
13.	Rock Music	"ROCK M"
14.	Easy Listening Music	"EASY M"
15.	Light Classical	"LIGHT M"
16.	Serious Classical	"CLASSICS"
17.	Other Music	"OTHER M"
18.	Weather	"WEATHER"
19.	Finance	"FINANCE"
20.	Children's programs	"CHILDREN"
21.	Social Affairs	"SOCIAL"
22.	Religion	"RELIGION"
23.	Phone In	"PHONE IN"
24.	Travel	"TRAVEL"
25.	Leisure	"LEISURE"
26.	Jazz Music	"JAZZ"
27.	Country Music	"COUNTRY"
28.	National Music	"NATION M"
29.	Oldies Music	"OLDIES"
30.	Folk Music	"FOLK M"
31.	Documentary	"DOCUMENT"



- Speech and Music include the Program type shown below.  
Music: No.12 — 17, 26 — 30

Speech: No.3 — 11, 18 — 25, 31

#### 3 Search for the selected Program Type station Press the right or left side of the Control knob.



- When the selected Program Type is not found, "NO PTY" is displayed. Select another Program Type.

#### 4 Exit PTY mode

Press the center of the Control knob.

### Program Type preset

Putting the Program Type in the Preset button memory and quick recall.

#### Presetting the Program Type

##### 1 Select the Program Type to preset

Refer to <PTY (Program Type)>.

##### 2 Preset the Program Type

Press the desired [1] — [6] button for at least 2 seconds.

#### Recalling the preset Program Type

##### 1 Enter PTY mode

Refer to <PTY (Program Type)>.

##### 2 Recall the Program Type

Press the desired [1] — [6] button.

### Changing Language for PTY Function

Selecting the Program Type display language.

#### 1 Enter PTY mode

Refer to <PTY (Program Type)>.

#### 2 Enter Changing Language mode

Press the [TI] button.

#### 3 Select the language

Press the top or bottom side of the Control knob.

Language	Display
English	"ENGLISH"
French	"FRENCH"
German	"GERMAN"

#### 4 Exit Changing Language mode

Press the center of the Control knob.

# Music disc/Audio file Operation

Function of KDC-W3541/KDC-W3041/KDC-W312/  
KDC-W241

Function of Audio file

## Folder Select

---

Quickly selecting the folder you want to hear.

### 1 Enter Folder Select mode

Press the [5] button.

"FLD SEL" is displayed.

Displays the current folder name.

### 2 Select the folder

Operation type	Operation
Movement between folders	Press the right or left side of the Control knob.
Selection of folder	Press the top side of the Control knob.
Return to previous folder	Press the bottom side of the Control knob.
Return to root folder	Press the [3] button.

### 3 Decide the folder to play

Press the center of the Control knob.

### Canceling the Folder Select mode

Press the [5] button.

# Menu Operation

## Menu System

Setting various functions.

### 1 Enter Menu mode

Press the [B.BOOST] button for at least 1 second.

"MENU" is displayed.

### 2 Select the menu item

Press the top or bottom side of the Control knob.

Display	Setting	Setting overview	Source
"CODE SET"	Refer to page 11	Sets security code. (Function of KDC-W3541)	<b>SB</b>
"CLK ADJ"	Refer to page 11	Sets the clock.	<b>SB</b>
"SYNC"*1	ON*/OFF	Synchronizing the RDS station time data and this unit's clock.	<b>SB</b>
"DIM"	ON/OFF*	Adjusts the brightness of the display according to the surrounding illumination.	
"SWPRE"*1*2	R*/ SW	Sets the preout output.	<b>SB</b>
"SPRM"*2	ON*/OFF	Turns ON/OFF the Supreme function.	<b>AF</b>
"NEWS"*1	OFF* - 90M	Turns ON/OFF the News Bulletin Automatic Reception function and sets the news bulletin interrupt disabled time.	<b>SB</b>
"LO.S"	ON/OFF*	Only stations whose reception is good are searched in auto seek tuning.	<b>FM</b>
"AUTO1"/ "AUTO2"/ "MANU"*1	AUTO1*/ AUTO2/ MANU	Selects the tuning mode of the radio.	<b>TUN</b>
"AF"*1	ON*/OFF	When station reception is poor, automatically switches to the station that is broadcasting the same program over the same RDS network.	<b>FM</b>
"REG"*1	ON*/OFF	Sets whether to switch to the station only in the specific region using the "AF" control.	<b>FM</b>
"ATPS"*1	ON*/OFF	When traffic information station reception is poor, automatically searches for a station that can be received better.	<b>FM</b>
"MONO"	ON/OFF*	Receives a stereo broadcast in the mono mode.	<b>FM</b>
"NAME SET"	Refer to page 12	Sets the display when switched to AUX source.	<b>AUX</b>
"RUS"*3	ON*/OFF	Selects Russian as the display language.	<b>SB</b>

Display	Setting	Setting overview	Source
"SCL"*2	AUTO/ MANU*	Specifies whether the text is scrolled automatically.	
"AUX"	OFF/ON1*/ ON2	Sets whether to display AUX during source selection.	<b>SB</b>
"OFF"	OFF - 60M	Turns off the power when the preset time has lapsed in the Standby mode.	<b>SB</b>
"CD READ"*2	1*/2	Sets the CD read mode.	<b>SB</b>
"DEMO"	Refer to page 12	Specifies whether to enable demonstration.	<b>SB</b>

\* Factory setting

\*1 This is not displayed on the KDC-W241.

\*2 This is not displayed on the KDC-241.

\*3 Function of Russian sales model.

**SB** : Can be set in standby state.

**SB** : Can be set in other than standby state.

**AF** : Can be set while Audio file source.

**TUN** : Can be set while Tuner source.

**FM** : Can be set during FM reception.

**AUX** : Can be set while accessing AUX source.



- Refer to the respective page for information on how to set the items with reference page number.
- Refer to the <Appendix> (page 13) for the details of the menu items.

### 3 Set the menu item

Press the right or left side of the Control knob.

### 4 Exit Menu mode

Press the [B.BOOST] button.

Function of KDC-W3541  
In Standby mode

## Security Code

When Security Code is set, possibility of theft is reduced because input of Security Code is prompted to turn on the unit once it is turned off.



- When you activate the Security Code function, it cannot be released.

Note, your Security Code is the 4 digit number entered in your "Car Audio Passport" in this package.

### 1 Enter Standby

Press the [SRC] button.

Select the "STANDBY" display.

### 2 Enter Menu mode

Press the [B.BOOST] button for at least 1 second.

When "MENU" is displayed, "CODE SET" is displayed.

### 3 Enter Security Code mode

Press the center of the Control knob for at least 1 second.

When "ENTER" is displayed, "CODE" is also displayed.

### 4 Select the digits to enter

Press the right or left side of the Control knob.

### 5 Select the Security Code numbers

Press the top or bottom side of the Control knob.

### 6 Repeat steps 4 and 5, and complete the Security Code.

### 7 Confirm the Security Code

Press the center of the Control knob for at least 3 seconds.

When "RE-ENTER" is displayed, "CODE" is also displayed.

### 8 Do the step 4 through 7 step operation, and reenter the security code.

"APPROVED" is displayed.

The Security Code function activates.



- If you enter a Code different from your Security Code, you have to start over from step 4.

### 9 Exit Security Code mode

Press the [B.BOOST] button.

## Resetting the Security Code function when the audio unit is first used after removed from the battery power source or the Reset button is pressed

### 1 Turn the power ON.

### 2 Do the step 4 through 7 step operation, and reenter the security code.

"APPROVED" is displayed.

Now, you can use the unit.



- If an incorrect code is entered, "WAITING" is displayed, and the input prohibition periods shown in the table below is generated.

After the input prohibition time lapses, "CODE" is displayed, and you can reenter the code.

Number of times the incorrect code was input	Input prohibited time
1	—
2	5 minutes
3	1 hour
4	24 hours

In Standby mode

## Manual Clock Adjustment

### 1 Enter Menu mode

Press the [B.BOOST] button for at least 1 second.

"MENU" is displayed.

### 2 Select Clock Adjustment mode

Press the top or bottom side of the Control knob.

Select the "CLK ADJ" display.

### 3 Enter Clock Adjust mode

Press the center of the Control knob for at least 1 second.

The clock display blinks.

### 4 Adjust the hours

Press the top or bottom side of the Control knob.

#### Adjust the minutes

Press the right or left side of the Control knob.

### 5 Exit Clock adjustment mode

Press the [B.BOOST] button.



- You can do this adjustment when the "SYNC" is set as "OFF".

# Menu Operation

## Auxiliary Input Display Setting

Selecting the display when changing to Auxiliary input source.

### 1 Select Auxiliary input source

Press the [SRC] button.

Select the "AUX" display.

### 2 Enter Menu mode

Press the [B.BOOST] button for at least 1 second.

"MENU" is displayed.

### 3 Select Auxiliary input display setting mode

Press the top or bottom side of the Control knob.

Select the "NAME SET" display.

### 4 Enter Auxiliary input display setting mode

Press the center of the Control knob for at least 1 second.

The presently selected Auxiliary input display is displayed.

### 5 Select the Auxiliary input display

Press the right or left side of the Control knob.

Each time you push the knob, the display alternates as listed below.

- "AUX"
- "DVD"
- "PORTABLE"
- "GAME"
- "VIDEO"
- "TV"

### 6 Exit Auxiliary input display setting mode

Press the [B.BOOST] button.



- When operation stops for 10 seconds, the name at that time is registered, and the Auxiliary input display setting mode closes.

*In Standby mode*

## Demonstration mode Setting

Sets the demonstration mode.

### 1 Enter Menu mode

Press the [B.BOOST] button for at least 1 second.

"MENU" is displayed.

### 2 Select the Demonstration mode

Press the top or bottom side of the Control knob.

Select the "DEMO" display.

### 3 Set the Demonstration mode

Press the center of the Control knob for at least 2 seconds.

Each time you press the knob at least 2 seconds, the Demonstration mode alternates between the settings shown in the table below.

Display	Setting
"DEMO ON"	The Demonstration mode function is ON.
"DEMO OFF"	Exit Demonstration mode (Normal mode).

# Appendix

## About Audio file

### • Playable Model

KDC-W3541, KDC-W3041, KDC-W312, KDC-W241

### • Playable Audio file

MP3 (.mp3), WMA (.wma)

### • Playable disc media

CD-R/RW/ROM

### • Playable disc file format

ISO 9660 Level 1/2, Joliet, Romeo, Long file name.

Although the audio files are complied with the standards listed above, the play maybe impossible depending on the types or conditions of media or device.

### • Playing order of the Audio file

In the example of folder/file tree shown below, the files are played in the order from ① to ⑩.

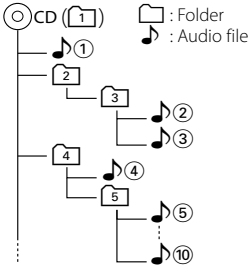

An online manual about audio files is put on the site, [www.kenwood.com/audiofile/](http://www.kenwood.com/audiofile/). On this online manual, detailed information and notes which are not written in this manual are provided. Make sure to read through the online manual as well.

## Menu Glossary

### • SWPRE (Switching Preout)

Switches the preout between rear output ("R") and subwoofer output ("SW").

### • SPRM (Supreme)

Technology to extrapolate and supplement with proprietary algorithm, the high-frequency range that is cut off when encoding at low bit rate. Supplementing is optimized by compression format (MP3 or WMA) and processed according to bit rate.

The effect is negligible with music that is encoded at high bit rate, variable bit rate or has minimal high frequency range.

### • CD READ

Sets the method for reading CD.

When unable to play special format CD, set this function to "2" to force playing. Note that some music CD may be unplayable even when set to "2". In addition, audio files cannot be played when set to "2". Normally, keep this set to "1".

1 : Automatically distinguishes between audio file disc and music CD when playing disc.

2 : Forces playing as music CD.

### • AUX

When this is set to ON, AUX source can be selected. ON1: Outputs the sound of external unit connected to the AUX terminal when switched to AUX source.

ON2: Activates the attenuator function when switched to AUX source.

Turn off the attenuator function when listening to output from external unit. This prevents the noise when no external unit is connected to AUX terminal.

OFF: Disables the selection of AUX source.

Set to OFF when not using the AUX terminal.

### • NEWS (News Bulletin with Timeout Setting)

Automatically receives news bulletin when it starts. Set the time during which interrupt is to be disabled after start of another news bulletin. Changing "NEWS 00M" to "NEWS 90M" turns this function ON. When this function is ON, the "NEWS" indicator is ON.

If news bulletin starts when this function is ON, "TRAFFIC" is displayed and news is received. If "20M" is has been set, reception of another news bulletin will not start for 20 minutes.

### • AUTO1, AUTO2, MANUAL (Tuning mode select)

Select a tuning mode of the radio.

Tuning mode	Display	Operation
Auto seek	"AUTO 1"	Automatic search for a station.
Preset station seek	"AUTO 2"	Search in order of the stations in the Preset memory.
Manual	"MANUAL"	Normal manual tuning control.

### • AF (Alternative Frequency)

When the reception is poor, automatically alternate to another frequency broadcasting the same program in the same RDS network with better reception.

### • RUS (Russian language setting)

When this is set to ON, the following character strings are displayed in Russian:

Folder name/ File name/ Song title/ Artist name/ Album name/ CD text (internal CD source)

А Б В Г Д Е Ж З И Й К Л М Н О П  
Р С Т У Ф Х Ц Ч Ш Щ Ъ Ы Ь Э Ю Я

Р С Т У Ф Х Ц Ч Ш Щ Ъ Ы Ь Э Ю Я  
Р С Т У Ф Х Ц Ч Ш Щ Ъ Ы Ь Э Ю Я

# Appendix

## • OFF (Power OFF Timer)

Setting the timer to turn this unit's power OFF automatically when Standby mode continues. Using this setting can save the vehicle's battery power.

-- -: Power OFF Timer function is OFF.

20M: Turns the power OFF after 20 minutes. (Factory setting)

40M: Turns the power OFF after 40 minutes.

60M: Turns the power OFF after 60 minutes.

## For operating KCA-BT100 (KDC-W3541)

To control KCA-BT100, operate as follows;

To make setting for <Selecting the Dialing Mode>, select <Menu System> (page 10). Pressing the [▶||] button for at least 1 second after selecting the "D.MODE" item allows you to enter the dialing method selection mode. To exit from dialing method selection mode, press [B.BOOST] button.

To make <Disconnecting a Call>, <Clearing the Disconnection Massage>, and <Rejecting an Incoming call>, press [AUTO] button for at least 1 second.

Moreover, some displays are different from the description of KCA-BT100 Instruction Manual.

Displays of KCA-BT100 Instruction Manual	Actual displays on KDC-W3541
"DISCONNECT"	"HF D-CON"
"CONNECT"	"HF CON"
"PHN-DEL"	"DVC-DEL"
"P-STATUS"	"D-STATUS"
"BT-CON Y"	"HF-CON Y"
"T-CON N"	"HF-CON N"

This Product is not installed by the manufacturer of a vehicle on the production line, nor by the professional importer of a vehicle into an EU Member State.

## Information on Disposal of Old Electrical and Electronic Equipment (applicable for EU countries that have adopted separate waste collection systems)



Products with the symbol (crossed-out wheeled bin) cannot be disposed as household waste.

Old electrical and electronic equipment should be recycled at a facility capable of handling these items and their waste byproducts. Contact your local authority for details in locating a recycle facility nearest to you. Proper recycling and waste disposal will help conserve resources whilst preventing detrimental effects on our health and the environment.

## The marking of products using lasers (Except for some areas)

**CLASS 1  
LASER PRODUCT**

The label is attached to the chassis/case and says that the component uses laser beams that have been classified as Class 1. It means that the unit is utilizing laser beams that are of a weaker class. There is no danger of hazardous radiation outside the unit.



## Declaration of Conformity with regard to the EMC Directive 2004/108/EC

### Manufacturer:

Kenwood Corporation

2967-3 Ishikawa-machi, Hachioji-shi, Tokyo, 192-8525 Japan

### EU Representative's:

Kenwood Electronics Europe BV

Amsterdamseweg 37, 1422 AC UITHOORN, The Netherlands

# Accessories/ Installation Procedure

## Accessories

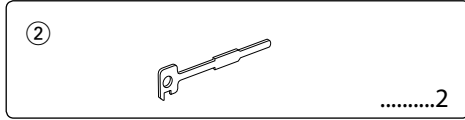
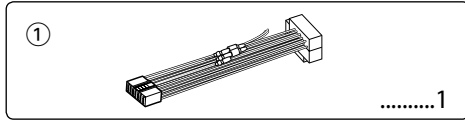

## Installation Procedure

1. To prevent short circuits, remove the key from the ignition and disconnect the ⊖ terminal of the battery.
2. Make the proper input and output wire connections for each unit.
3. Connect the wire on the wiring harness.
4. Take Connector B on the wiring harness and connect it to the speaker connector in your vehicle.
5. Take Connector A on the wiring harness and connect it to the external power connector on your vehicle.
6. Connect the wiring harness connector to the unit.
7. Install the unit in your car.
8. Reconnect the ⊖ terminal of the battery.
9. Press the reset button.



- Mounting and wiring this product requires skills and experience. For safety's sake, leave the mounting and wiring work to professionals.
- Make sure to ground the unit to a negative 12V DC power supply.
- Do not install the unit in a spot exposed to direct sunlight or excessive heat or humidity. Also avoid places with too much dust or the possibility of water splashing.
- Do not use your own screws. Use only the screws provided. If you use the wrong screws, you could damage the unit.
- If the power is not turned ON ("PROTECT" is displayed), the speaker wire may have a short-circuit or touched the chassis of the vehicle and the protection function may have been activated. Therefore, the speaker wire should be checked.
- Make sure that all wire connections are securely made by inserting jacks until they lock completely.
- If your vehicle's ignition does not have an ACC position, or if the ignition wire is connected to a power source with constant voltage such as a battery wire, the power will not be linked with the ignition (i.e., it will not turn on and off along with the ignition). If you want to link the unit's power

with the ignition, connect the ignition wire to a power source that can be turned on and off with the ignition key.

- Use a commercially available conversion connector if the connector does not fit in the vehicle connector.
- Insulate unconnected wires with vinyl tape or other similar material. To prevent a short circuit, do not remove the caps on the ends of the unconnected wires or the terminals.
- If the console has a lid, make sure to install the unit so that the faceplate will not hit the lid when closing and opening.
- If the fuse blows, first make sure the wires aren't touching to cause a short circuit, then replace the old fuse with one with the same rating.
- Connect the speaker wires correctly to the terminals to which they correspond. The unit may be damaged or fail to work if you share the ⊖ wires or ground them to any metal part in the car.
- After the unit is installed, check whether the brake lamps, blinkers, wipers, etc. on the car are working properly.
- Mount the unit so that the mounting angle is 30° or less.

## About CD players/disc changers connected to this unit

Kenwood disc changers/ CD players released in 1998 or later can be connected to this unit. Refer to the catalog or consult your Kenwood dealer for connectable models of disc changers/ CD players. Note that any Kenwood disc changers/ CD players released in 1997 or earlier and disc changers made by other makers cannot be connected to this unit. Connecting unsupported disc changers/CD players to this unit may result in damage. Set the "O-N" Switch to the "N" position for the applicable Kenwood disc changers/ CD players. The functions you can use and the information that can be displayed may differ depending on the models being connected.

# Connecting Wires to Terminals

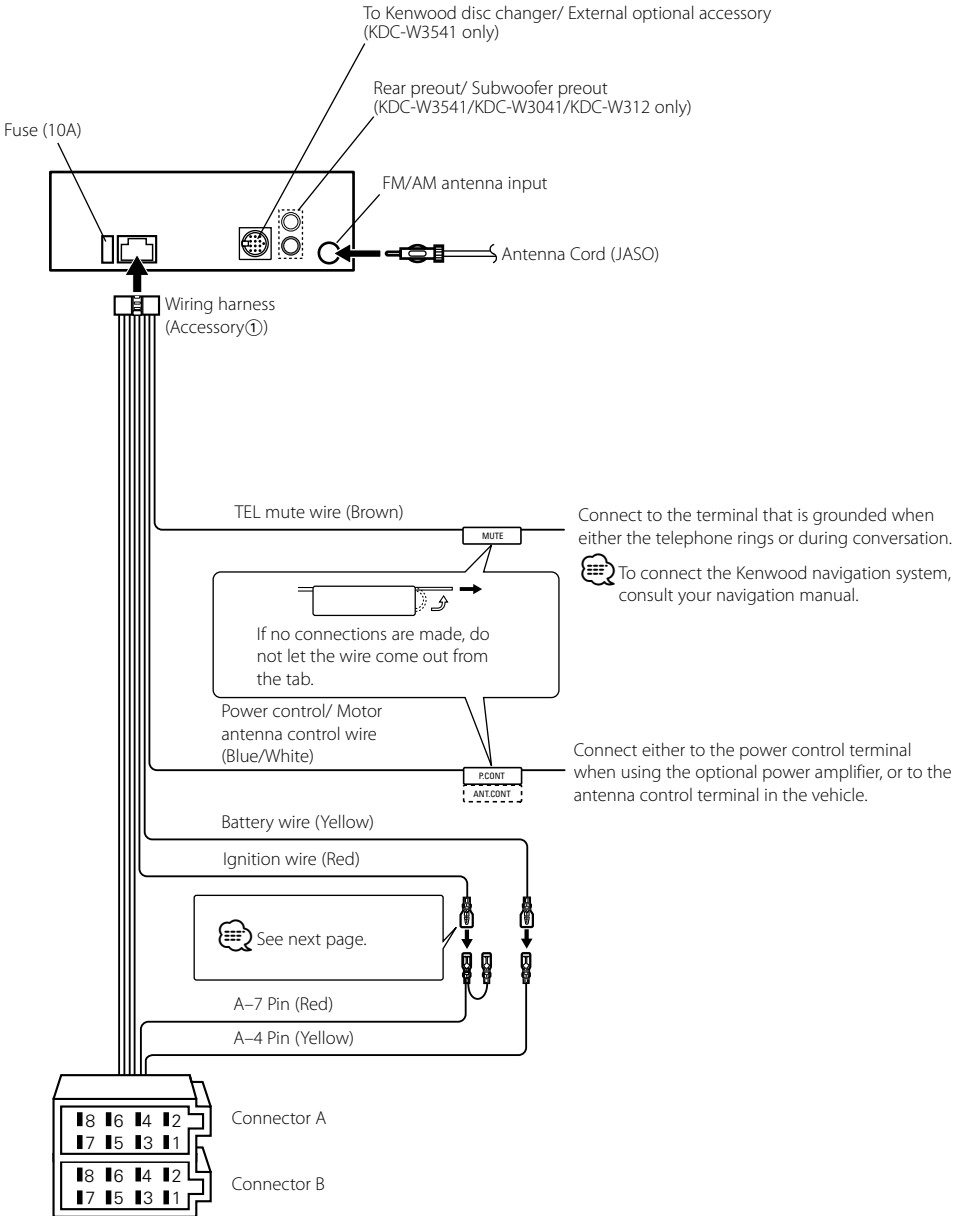

## Connector Function Guide

Pin Numbers for ISO Connectors	Cable Colour	Functions
External Power Connector		
A-4	Yellow	Battery
A-5	Blue/White	Power Control
A-7	Red	Ignition (ACC)
A-8	Black	Earth (Ground) Connection
Speaker Connector		
B-1	Purple	Rear Right (+)
B-2	Purple/Black	Rear Right (-)
B-3	Gray	Front Right (+)
B-4	Gray/Black	Front Right (-)
B-5	White	Front Left (+)
B-6	White/Black	Front Left (-)
B-7	Green	Rear Left (+)
B-8	Green/Black	Rear Left (-)

## ⚠ WARNING

### Connecting the ISO Connector

The pin arrangement for the ISO connectors depends on the type of vehicle you drive. Make sure to make the proper connections to prevent damage to the unit.

The default connection for the wiring harness is described in [1] below. If the ISO connector pins are set as described in [2] or [3], make the connection as illustrated.

Please be sure to reconnect the cable as shown [2] below to install this unit to the **Volkswagen** vehicles etc.

- [1] (Default setting) The A-7 pin (red) of the vehicle's ISO connector is linked with the ignition, and the A-4 pin (yellow) is connected to the constant power supply.

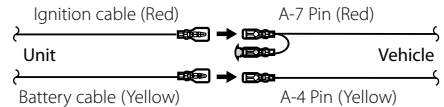

- [2] The A-7 pin (red) of the vehicle's ISO connector is connected to the constant power supply, and the A-4 pin (yellow) is linked to the ignition.

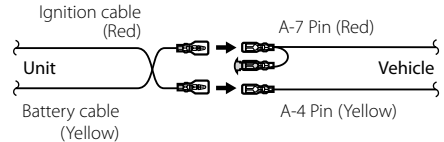

- [3] The A-4 pin (yellow) of the vehicle's ISO connector is not connected to anything, while the A-7 pin (red) is connected to the constant power supply (or both the A-7 (red) and A-4 (yellow) pins are connected to the constant power supply).

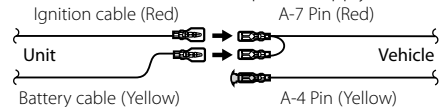

- When the connection is made as in [3] above, the unit's power will not be linked to the ignition key. For that reason, always make sure to turn off the unit's power when the ignition is turned off.

To link the unit's power to the ignition, connect the ignition cable (ACC...red) to a power source that can be turned on and off with the ignition key.

# Installation/Removing the Unit

## Installation

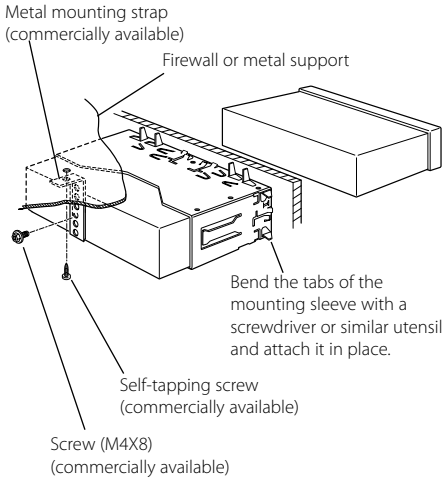

- Make sure that the unit is installed securely in place. If the unit is unstable, it may malfunction (for example, the sound may skip).

## Removing the hard rubber frame

- 1 Engage the catch pins on the removal tool and remove the two locks on the upper level. Upper the frame and pull it forward as shown in the figure.

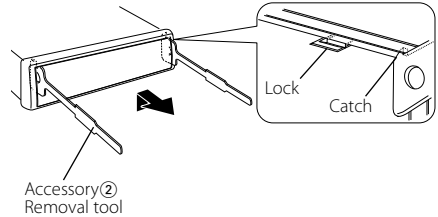

- 2 When the upper level is removed, remove the lower two locations.



- The frame can be removed from the bottom side in the same manner.

## Removing the Unit

- 1 Refer to the section <Removing the hard rubber frame> and then remove the hard rubber frame.
- 2 Remove the screw (M4 x 8) on the back panel.
- 3 Insert the two removal tools deeply into the slots on each side, as shown.
- 4 Lower the removal tool toward the bottom, and pull out the unit halfway while pressing towards the inside.

Screw (M4X8) (commercially available)

Accessory②

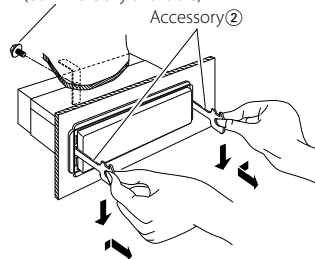

- Be careful to avoid injury from the catch pins on the removal tool.
- 5 Pull the unit all the way out with your hands, being careful not to drop it.

# Troubleshooting Guide

Some functions of this unit may be disabled by some settings made on this unit.

## ! Cannot display the user of System Q.

- ▶ <Audio Control> (page 6) is not set.

## ! • Cannot set up the subwoofer.

- **No output from the subwoofer.**
- **Cannot set up the low pass filter.**
- ▶ • Preout is not set to subwoofer.  <Menu System> (page 10)
  - <Subwoofer output> (page 4) is not set to On.

## ! • Cannot register a security code.

- **Cannot set up Display.**
- ▶ <Demonstration mode Setting> (page 12) is not turned off.

What might seem to be a malfunction in your unit may just be the result of slight misoperation or miswiring. Before calling service, first check the following table for possible problems.



## Tuner source

### ? Radio reception is poor.

- ✓ The car antenna is not extended.  
 Pull the antenna out all the way.



## Disc source

### ? The specified disc does not play, but another one plays instead.







- ✓ The specified CD is quite dirty.  
 Clean the CD.
- ✓ The disc is loaded in a different slot from that specified.  
 Eject the disc magazine and check the number for the specified disc.
- ✓ The disc is severely scratched.  
 Try another disc instead.

## Audio file source

### ? The sound skips when an Audio file is being played.

- ✓ The media is scratched or dirty.  
 Clean the media, referring to the CD cleaning of the section on <Handling CDs> (page 3).
- ✓ The recording condition is bad.  
 Record the media again or use another media.

## The messages shown below display your systems condition.

TOC ERR:	<ul style="list-style-type: none"><li>• No disc has been loaded in the disc magazine.</li><li>• The CD is quite dirty. The CD is upside-down. The CD is scratched a lot.</li></ul>
E-05:	The disc is unreadable.
E-15:	Media was played that doesn't have data recorded that the unit can play.
E-77:	The unit is malfunctioning for some reason.  Press the reset button on the unit. If the "E-77" code does not disappear, consult your nearest service center.
E-99:	Something is wrong with the disc magazine. Or the unit is malfunctioning for some reason.  Check the disc magazine. And then press the reset button on the unit. If the "E-99" code does not disappear, consult your nearest service center.
IN (Blink):	The CD player section is not operating properly.  Reinsert the CD. If the CD cannot be ejected or the display continues to flash even when the CD has been properly reinserted, please switch off the power and consult your nearest service center.
PROTECT:	The speaker wire has a short-circuit or touches the chassis of the vehicle, and then the protection function is activated.  Wire or insulate the speaker cable properly and press the reset button. If the "PROTECT" code does not disappear, consult your nearest service center.
NA FILE:	An Audio file is played with a format that this unit can't support.  ----
COPY PRO:	A copy-protected file is played.  ----

# Specifications

## FM tuner section

---

Frequency range (50 kHz space)  
: 87.5 MHz – 108.0 MHz  
Usable sensitivity (S/N = 26dB)  
: 0.7  $\mu$ V/75  $\Omega$   
Quieting Sensitivity (S/N = 46dB)  
: 1.6  $\mu$ V/75  $\Omega$   
Frequency response ( $\pm$ 3.0 dB)  
: 30 Hz – 15 kHz  
Signal to Noise ratio (MONO)  
: 65 dB  
Selectivity (DIN) ( $\pm$ 400 kHz)  
:  $\geq$  80 dB  
Stereo separation (1 kHz)  
: 35 dB

## MW tuner section

---

Frequency range (9 kHz space)  
: 531 kHz – 1611 kHz  
Usable sensitivity (S/N = 20dB)  
: 25  $\mu$ V

## LW tuner section

---

Frequency range  
: 153 kHz – 281 kHz  
Usable sensitivity (S/N = 20dB)  
: 45  $\mu$ V

## CD player section

---

Laser diode  
: GaAlAs  
Digital filter (D/A)  
: 8 Times Over Sampling  
D/A Converter  
: 1 Bit  
Spindle speed  
: 500 – 200 rpm (CLV)  
Wow & Flutter  
: Below Measurable Limit  
Frequency response ( $\pm$ 1 dB)  
: 20 Hz – 20 kHz  
Total harmonic distortion (1 kHz)  
: 0.01 %  
Signal to Noise ratio (1 kHz)  
KDC-W3541/W3041/W312/W241 : 105 dB  
KDC-241 : 93 dB  
Dynamic range  
: 93 dB  
MP3 decode (KDC-W3541/W3041/W312/W241)  
: Compliant with MPEG-1/2 Audio Layer-3  
WMA decode (KDC-W3541/W3041/W312/W241)  
: Compliant with Windows Media Audio

## Audio section

---

Maximum output power  
KDC-W3541/W3041/W312/W241 : 50 W x 4  
KDC-241 : 45 W x 4  
Full Bandwidth Power (at less than 1% THD)  
KDC-W3541/W3041/W312/W241 : 30 W x 4  
KDC-241 : 28 W x 4  
Speaker Impedance  
: 4 – 8  $\Omega$   
Tone action  
Bass : 100 Hz  $\pm$ 8 dB  
Middle : 1 kHz  $\pm$ 8 dB  
Treble : 10 kHz  $\pm$ 8 dB  
Preout level / Load (CD) (KDC-W3541/W3041/  
W312)  
: 2000 mV/10 k $\Omega$   
Preout impedance (KDC-W3541/W3041/W312)  
:  $\leq$  600  $\Omega$

## Auxiliary input

---

Frequency response ( $\pm$ 3 dB)  
: 20 Hz – 20 kHz  
Input Maximum Voltage  
: 1200 mV  
Input Impedance  
: 100 k $\Omega$

## General

---

Operating voltage (11 – 16V allowable)  
: 14.4 V  
Current consumption  
: 10 A  
Installation Size (W x H x D)  
: 182 x 53 x 155 mm  
Weight  
: 1.30 kg

Specifications subject to change without notice.